



Radiant Ceiling Systems

**Our passion
never stops growing.
Just like our Group.**

To be the best you need the **right numbers.**

Such numbers are what makes **our group** one of today's **world leaders** in the production of heating, conditioning and sanitary water distribution components and systems for the residential, industrial and commercial sectors. A reality constantly expanding, just like our goals.

1951

COMPANY
ESTABLISHMENT

More than **900 EMPLOYEES**

70 TONS
OF BRASS DAILY

130,000 m² PRODUCTION PLANTS

A TURNOVER
CLOSE TO **170** millions

80 % EXPORT



BRANCHES, REPRESENTATIVE OFFICES AND EXCLUSIVE PARTNERS

- | | | | | |
|------------|---------------|-------------|------------------|------------|
| ① ITALY | ⑤ ENGLAND | ⑨ POLAND | ⑬ CANADA | ⑰ JORDANIA |
| ② FRANCE | ⑥ BELGIAN | ⑩ CHINA | ⑭ CZECH REPUBLIC | ⑱ INDIA |
| ③ SPAIN | ⑦ SWITZERLAND | ⑪ BRAZIL | ⑮ SLOVAKIA | ⑲ RUSSIA |
| ④ PORTUGAL | ⑧ GERMANY | ⑫ ARGENTINA | ⑯ TURKEY | |

Radiant Systems. Technical innovation for the ideal climate.



Components for optimization of energy consumptions and metering, distribution of hot and cold fluids.



Radiant floor and wall conditioning, counter-ceilings for residential and commercial use, thermoregulation and air treatment.



Components for sanitary water distribution lines and sanitary water system devices.



Distribution products and systems for safe and performing gas transfers.



Components for energy production systems from renewable sources.



Specialized performing components for the professional fire-prevention sector.

INDEX

1 - Radiant ceiling systems	page 8	5 - Cooling and air treatment	page 90
2 - Metal radiant ceilings	page 28	6 - Regulation	page 98
3 - Plasterboard radiant ceilings	page 62	7 - The system project	page 114
4 - Output	page 80	8 - General prescriptions and testing procedures	page 124

The highest levels of comfort and air quality with first-class energy-saving performance. Radiant ceilings are just a winning choice.

Chapter 1

Radiant Ceiling Systems

INTRODUCTION

Radiant ceiling systems represent a modern and efficient solution to heat, cool and decorate the ambients where people generally spend most of their time: houses, offices, schools, showrooms, hotels, hospitals, museums are just an example of their main applications.

From a mere installation standpoint, radiant ceilings are hydronic systems balancing the sensible loads of air-conditioned spaces and that combined with auxiliary systems, guarantee the most suitable ventilation conditions and keep under control humidity levels.

The physical phenomenon characterizing thermal exchange between radiant ceilings and the ambient of installation is known as irradiation.

IRRADIATION, THE INVISIBLE STRANGER

Despite radiant ceiling systems have been experiencing a steady growth during the last twenty years, offering many people the opportunity to experience first-hand their comfortable “radiant” feeling, the general prejudice that “*heat cannot come from above because hot air tends to climb*” is still widespread, and installers often have to find a way to overcome – but only with those not active in this sector – this misbelief.

Radiant ceilings, with their natural simplicity, are nothing but one of man’s many successful attempts to translate a spontaneous phenomenon from nature into technology.

Just as airplanes were invented by observing a bird’s flight, we can also find a correspondence between the mechanism based on which the sun heats the Earth and radiant ceilings systems.

The keyword: **irradiation**.

But how can one experience it without a radiant ceiling?

The simplest way – and of course not the only one – is to stand under the sun on a clear winter day: who has never tried first hand that with a 9-10 °C air temperature one just needs a sweater to feel comfortable?

And who has never noticed that sweaters of different colors are more or less warm?

This is what we call irradiation; we cannot touch the sun and air can only make us feel cold, but the percentage of irradiation heat is higher than the one which cold air takes from us: the general sensation is pleasant.

By exploiting the infrared field vision, one can have a clear idea of what happens in real life when a radiant ceiling is used to heat.

Picture 1.1 refers to a room heated by a plasterboard radiant ceiling.

Water at 35 °C flows through the coil inside the panel. The black and blue areas show the lowest temperatures, red and yellow the highest.

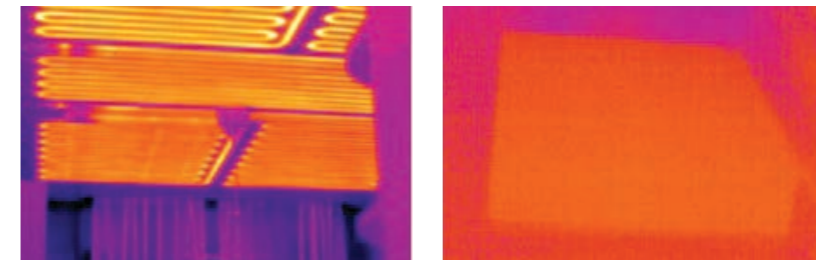

fig. 1.1 Thermovision of a heating radiant ceiling.

It is clear – picture on the left – how the windows of the large French door are cold, while the curtains show both cold areas and areas affected by the irradiation heating by the radiant ceiling.

The picture on the right is the most significant. It shows the most essential element: the floor below the ceiling radiant panel receives heat in an optimal way and in turn it heats up more than the other objects – walls and furnishings – inside the room; the wall on the right is also affected by this thermal exchange and raises its temperature.

The effect of irradiation is to change the temperature of the surfaces that delimit the ambients: this happens independently from the reciprocal position of the surfaces themselves: the more they face one another, the more intense is the exchange, obviously under the same conditions (ceiling surface temperature, materials, emissivity, material blackness degree etc.).

PREROGATIVES OF RADIANT CEILINGS

Radiant ceiling systems represent an efficient solution for heating and cooling. They also confer a high level of comfort and guarantee the achievement of the best energy saving targets. Compared to traditional air conditioning systems, radiant ceilings play a winning role for their multiple peculiarities:

- > Energy saving
- > Air quality
- > Space availability
- > Noise reduction
- > Reduced maintenance costs
- > Reactiveness
- > Comfort
- > Modularity and flexibility
- > Rapid installation
- > Preassembled in-house
- > Inspectionability

Energy saving

The use of radiant ceilings to cut down sensible loads enables to reduce to the minimum ventilation air needs, based on the estimated crowding and space use.

The enhanced thermal capacity of water compared to air makes the transportation of the same quantity of heat more efficient with a radiant ceiling versus air systems: this leads to important energy saving by cutting down the costs of electric energy, generally consumed by traditional fans.

The water temperature required by radiant ceilings represents another added value. The specific power which the radiant ceiling exchanges with the room is the sum of a convective exchange component, weighing approximately 25% of the total, and an irradiation exchange component, equal to a total of approximately 75%.

The convective exchange q_c between the radiant ceiling and the room air is expressed as:

$$q_c = \alpha \cdot (T_{\text{room air}} - T_{\text{panel surface}}) \text{ [W/m}^2\text{]}$$

The irradiation exchange q_i between the ceiling and all the room surfaces can be expressed as:

$$q_i = 5,67 \cdot 10^{-8} \cdot \epsilon \cdot F \cdot (T_{\text{surface}}^4 - T_{\text{panel surface}}^4) \text{ [W/m}^2\text{]}$$

Where:

α = convective thermal exchange coefficient [W/m² K]

ϵ = function considering the emissivity of the surfaces in play, dimensionless value

F = view factor between the radiant ceiling and the generic surface, dimensionless value

$T_{\text{room air}}$ = room air temperature, in K

T_{surface}^4 = fourth power of the generic surface temperature, in K

$T_{\text{panel surface}}^4$ = fourth power of the radiant panel surface temperature, in K

The formulas clearly show how the radiant panel surface temperature, closely connected to the delivery water temperature, is enhanced during the irradiation exchange due to raising to the fourth power. This is the reason why radiant ceilings typically work with water at 15 °C when cooling and 35 °C when heating. On the contrary, traditional air systems – where thermal exchange occurs only by convection – require water at 6-7 °C when cooling and 50-60 °C when heating. It is clear how radiant systems provide for full exploitation, and the best performance, of modern heating and cooling systems.

Finally, an in-depth observation of what happens inside the room. In addition to the humidity ratio, the operating temperature T_o , expressed as $T_o = (T_s + T_a)/2$ is what determines the wellness feeling; in other words, the operating temperature is the arithmetical average between the average temperature of all the surfaces – T_s – that delimit the ambient and its air temperature – T_a .

When considering the cooling regime, we may expect that the operating temperature of 25 °C is obtainable with a traditional system that sets the air temperature at 23 °C and the surfaces (floor, ceiling, walls) at 27 °C; on the other hand, a radiant ceiling would enable to achieve the same 25 °C operating temperature with room air at 27 °C and with an average surface temperature of 23 °C. It is clear how the heat irradiated from the outside, that we may assume to be at 35 °C, toward the ambient are greater when the room air is at 23 °C.

The same consideration is also valid for the winter regime.

Once again, radiant ceilings represent the perfect solution to take a decisive step toward major building energy savings.

Air quality

Radiant ceilings can be virtually exploited in a wide range of practical applications, especially when the sensible loads are preponderant or in ambients where high levels of indoor air quality are required: it is not by chance that they have been widely used in hospitals in the last fifteen years.

They ensure the best qualitative air conditions in the rooms as they are paired with ventilation systems for air exchange and humidity control.

In winter, the false ceiling reaches 28-30 °C surface temperatures, while the air temperature, as explained above for the operating temperature, remains at about 18-19 °C, immediately offering less dry air.

In summer, dehumidification machines distributed in multiple points of the building are no longer required, also completely eliminating the issues connected to poor, or inexistent, maintenance: wet coils and moisture collection containers are in fact the ideal location for the proliferation of bacteria and fungi. As opposed, one single centralized system for air exchange and humidity control provides for indirect dehumidification and dry air is thus distributed through the ducts which prevent the proliferation of pathogen or allergenic organisms with their low humidity rate.

Availability of space

Bad habits prove our natural inclination of growing deep roots and to define as 'normal' and 'expected' what is not actually so.

From a constructor and occupant's point of view, the elevated economic value of the volumes is crystal clear. However, it is not that evident to understand that traditional air conditioning systems – air-only or with fan coils – subtract volume from the occupants.

The picture below takes into consideration the same ambient, ideally air conditioned with an only-air system (1.2 – left) and with a radiant ceiling + primary air combined system (1.2 – right).

Vertical space recovery

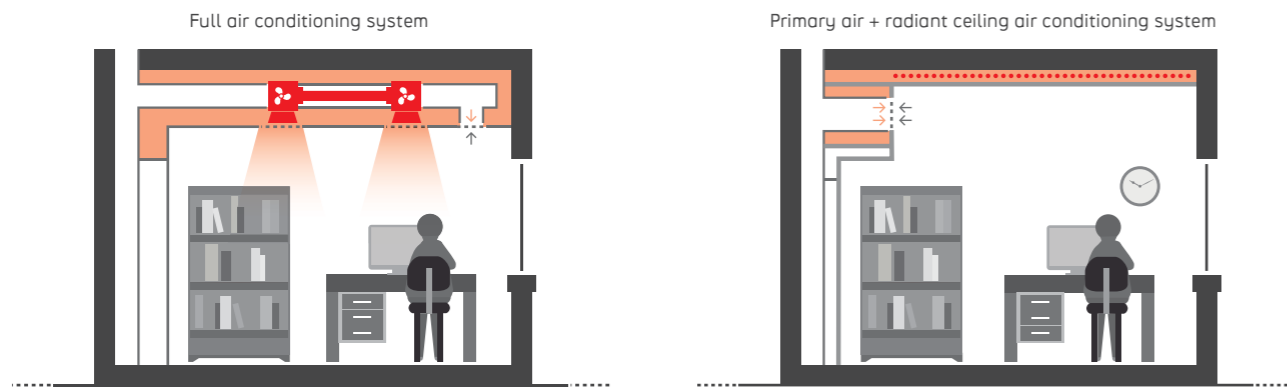

fig. 1.2 Vertical space recovery

It is clear how only-air systems require greater vertical spaces as opposed to radiant ceilings combined to primary air; in multi-storey buildings, typical of the commercial sector, such reduction of “technical volumes” can rapidly reach the equivalent height of a full additional storey.

To make this concept easier, just think of a 10-storey building where each floor requires 50 cm for the only-air system, while a radiant ceiling would just need 20 cm: 30 cm recovered for each floor sum up to 3 metres on 10 floors.

Likewise, the picture below shows the same ambient ideally conditioned with a fan coil + primary air combined system (1.3 – left) and with a radiant ceiling + primary air combined system (fig. 1.3 – right).

Horizontal space recovery

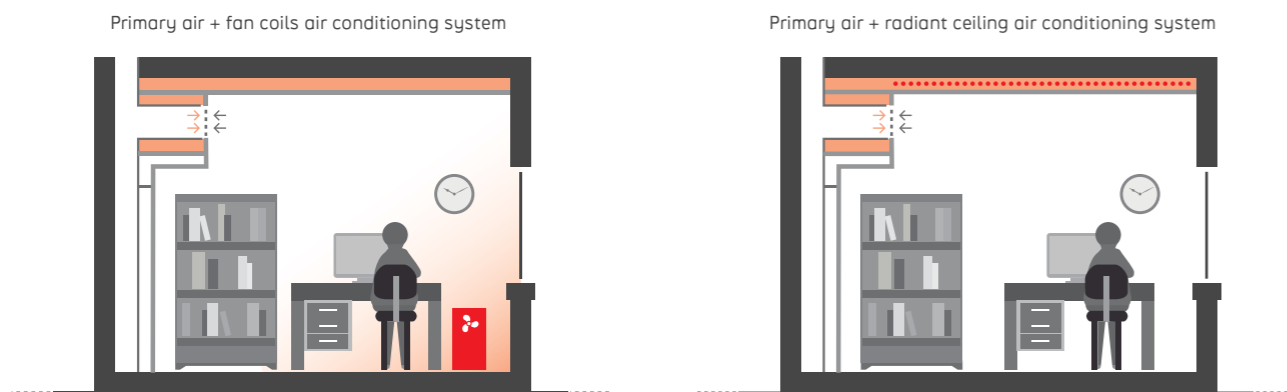

fig. 1.3 Space recovery in the occupied area

This second consideration can be easily extended also to residential buildings, where radiators and fan coils are still widespread.

The picture clearly shows (fig. 1.3 – left) how the installation of a terminal unit subtracts volume: with its overall dimensions, for the distances required to guarantee correct functioning and to enable the occupants to maintain an adequate distance to prevent discomfort.

Radiant ceilings do not take subtract space from the occupied areas nor from the walls.

In the end, considering that the examples given above generally provide for traditional false ceilings, it is easy to assume that radiant ceilings do not affect in any way the availability of space.

Noise reduction

It is evident that, under equal conditions, an ambient is less comfortable the higher the level of perceivable noise. Who has never spent a night in a hotel and had to call the reception at midnight to ask them to turn off the too noisy, unhygienic fan coil?

The drastic reduction of the air flow to be managed with radiant ceilings and their remote location as opposed to the space required by ventilation machines provides for a great reduction of the noise typical of air-movement based systems, offering everyone the opportunity to enjoy a quiet and relaxed living experience.

Reduced maintenance costs

Radiant ceilings enable to remarkably reduce the costs connected to ordinary maintenance – no moving mechanical parts, no unit terminal, filters, or engines to be replaced – and ensures a longer useful life compared to the one reasonably expected for traditional systems.

Reactivity

Radiant ceilings are characterized by short-term thermal transitions.

When considering metal panels, their thermal inertia is essentially the same of the water flowing inside; with plasterboard panels the transition duration is imposed by the inertia of the plasterboard sheet.

By using a thermovision camera we can see the evolution of the thermal transition. The pictures below clearly show the activation phases of a metal radiant ceiling and a plasterboard panel. Of course, the deactivation transitions feature the same dynamics.

Both cases clearly show the high reactivity level of the system.



fig. 1.4 Thermovision camera

Metal radiant ceiling:

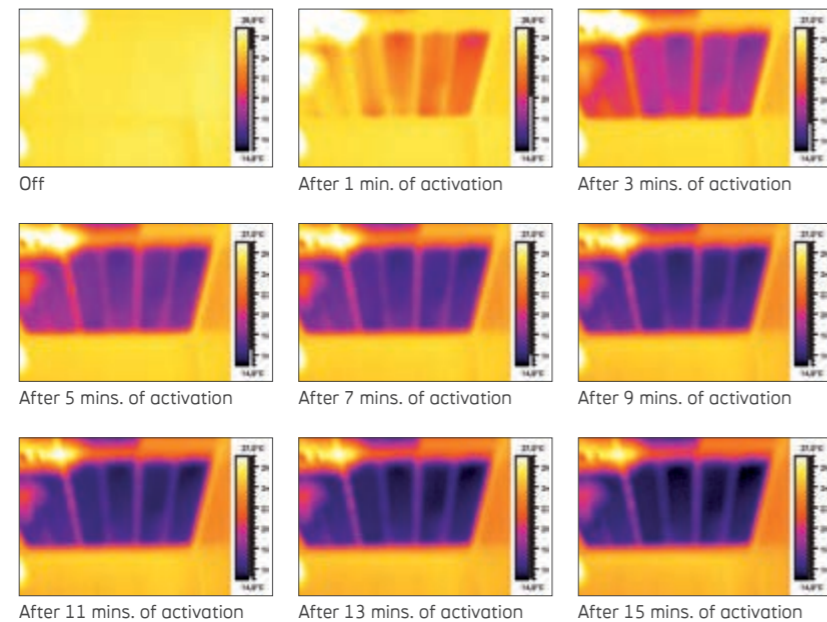

fig. 1.5
Transition of a metal radiant ceiling

Plasterboard radiant ceiling:

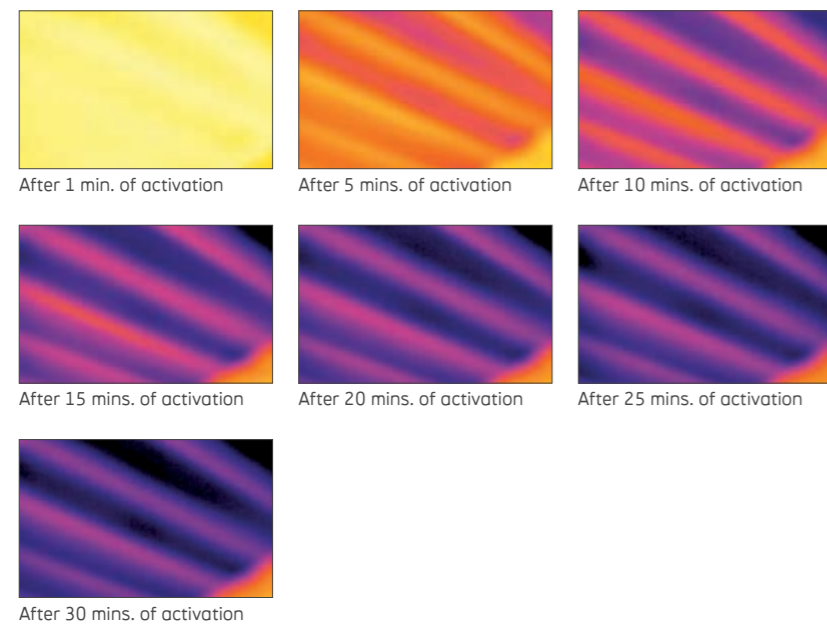

fig. 1.6
Transition of a plasterboard radiant ceiling

Comfort

Radiant ceiling systems represent the best installation solution to achieve the highest levels of comfort.

The important concept of comfort has been widely investigated through researches at the end of the last century; yet, in everyday's life, we actually pay little attention to their great scientific results and it usually takes years before "analytical news" actually become an integral part of a more consolidated practice.

If we imagine a climatized environment in terms of comfort, we generally focus on hot, cold and humidity. One may recall - for

example – an uncomfortable dinner in a restaurant while sitting close to an air diffuser ejecting cold air.

These are all valid and correct observations, but the concept of comfort is far more extensive - as we actually could guess by reading the paragraph dedicated to noise reduction.

Today we can rely on objective tools and methods to actually quantify, and not just describe in terms of quality, the level of comfort of an ambient.

The regulations of reference are:

- > EN ISO 7730: Analytical determination and interpretation of thermal comfort using calculation of the PMV and PPD
- > EN 15251: Criteria for the Indoor Environment including thermal, indoor air quality, light and noise
- > EN 13779: Ventilation for non-residential buildings. Performance requirements for ventilation and room conditioning systems

To the effects of comfort as a strict thermal feeling, without considering factors such as smell sensations, lights and noise, the EN ISO 7730 rule shall apply, which appeared for the first time in 1994 and subsequently integrated¹.

In short, the thermal comfort level is expressed by the Predicted Percentage of Dissatisfied - PPD.

In order to better understand this variable, one may imagine to ask a sample of individuals standing in a room how comfortable they feel: some will feel hot, some will feel too hot, others a little cold... let's say we have conferred the idea.

This evaluation is given in terms of quality by the Predicted Mean Vote – PMV, a variable considering the parameters included in a range that goes with a central zero, from -3 (extremely cold) to +3 (extremely hot) by and which expresses the level of thermal wellness perceived by the sample of individuals.

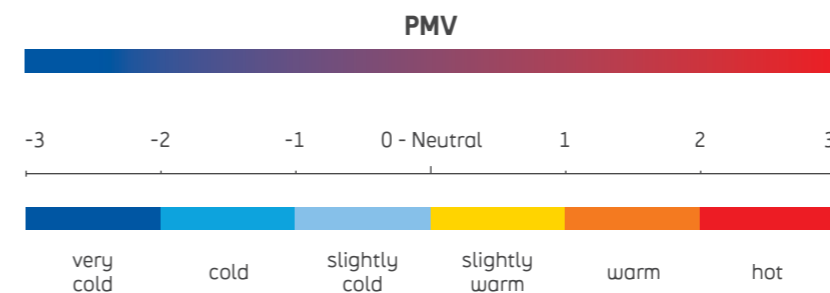

fig. 1.7
Predicted Mean Vote Scale

The PPD global index of thermal comfort is expressed based on the PMV², in turn determined through a set of parametrical equations where physical dimensions which characterize comfort are involved – metabolic activity, wet and dry bulb air temperature, relative humidity, air speed, average surface temperature, operating temperature.

NOTES

¹ UNI EN ISO 7730:2006, - Ergonomics of thermal ambients – Analytic determination and interpretation of thermal wellness through the calculation of PMV and PPD indexes and criteria of local thermal wellness.

² PPD = 100 - 95 · exp (-0,03353 · PMV⁴ - 0,2179 PMV³)

In addition to this main index, the Regulation takes into consideration the factors³ responsible for local discomfort:

- > Air currents (DR % – Draught Rate)
- > Temperature vertical gradient
- > Radiant asymmetry
- > Floor temperature

and it classifies three categories of thermal comfort A, B, and C. The following table summarizes the evaluation of comfort according to UNI EN ISO 7730:2006.

NOTES
³ For a detailed definition of the above please refer to UNI EN ISO 7730:2006.

category	GLOBAL COMFORT			LOCAL DISCOMFORT		
	PPD %	PMV	DR %	temperature vertical gradient [°C]	hot or cold floor [°C]	radiant asymmetry [°C]
A	<6	-0,2 < PMV < 0,2	<10	<3	<10	<5
B	<10	-0,5 < PMV < 0,5	<20	<5	<10	<5
C	<15	-0,7 < PMV < 0,7	<30	<10	<15	<10

Category B, which requires a PPD index lower than 10%, includes most residential and commercial applications suitable for radiant ceilings: it should also represent the comfort target for new constructions and requalification interventions of the existing building patrimony.

With regards to the temperature vertical gradient, and keeping in mind the thermal pictures showing the irradiation phenomenon, the following diagram would be a typical representation:

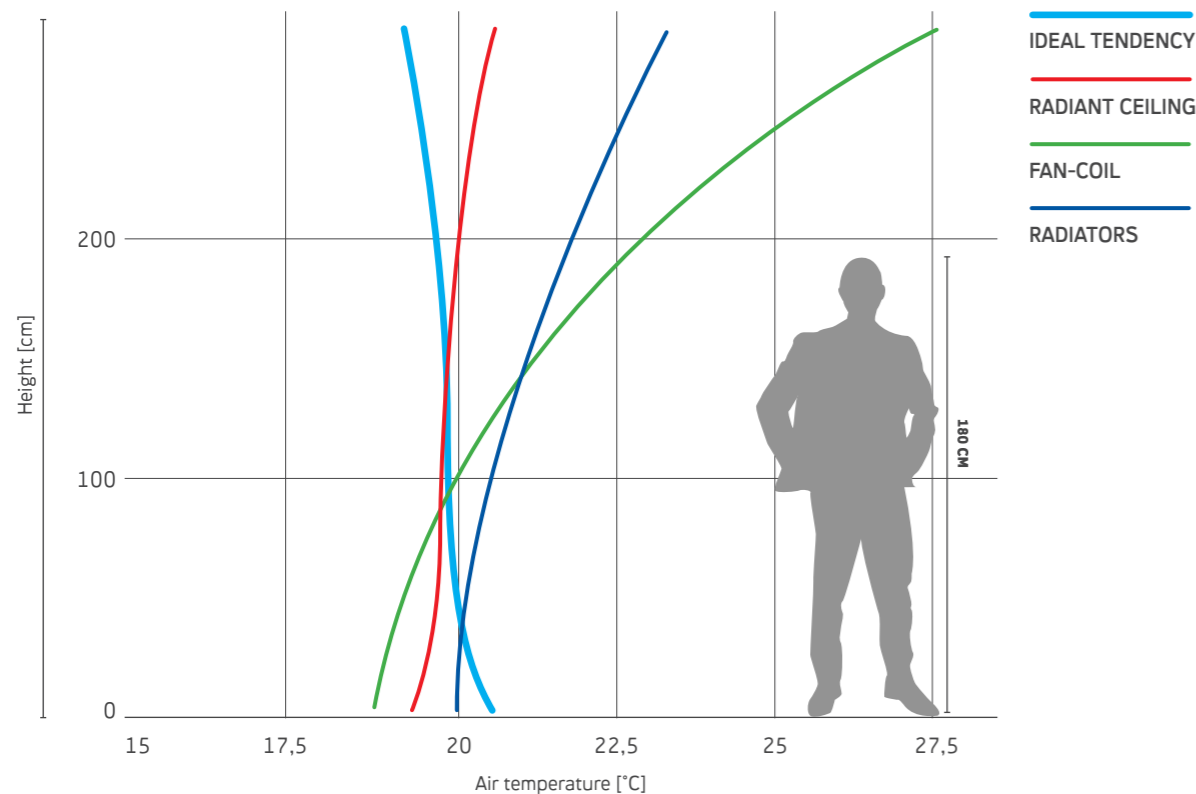

fig. 1.8 Temperature vertical distribution for typical heating systems

The picture distinctly shows how a radiant ceiling is free from any air stratification when heating. The temperature difference between the floor-level and ceiling-level air is extremely contained and it is far lower than the one obtained with traditional heating systems.

This effect becomes an essential coefficient to reduce of air movements - which also furtherly reduce heat dispersion toward the walls and increase comfort levels considerably: here is great resemblance between the ambient temperature ideal tendency and the temperature vertical profile of radiant ceilings. This is a beneficial result which preconceived ideas would not have taken into consideration.

As an additional proof of the comfort reasonably expected from radiant ceilings, below are the specific results from experimental tests by Giacomini S.p.A.

Comfort measurements: the meeting room

The first ambient is a tough testing ground for radiant ceiling systems: a meeting room where the latent loads may cause the distribution of variable air flows up to 4-5 vol/h, based on the crowding, far greater than typical 2 vol/h generally required for ordinary offices – this is an uphill start considering a PPD target lower than 10% and with no air currents.

The room has been used normally during the test which has been extended automatically along a significant period of time for the evaluation of the comfort levels.

The test was performed on a day of July when the outdoor temperature varied between 17 °C during the night and over 32 °C in the afternoon.

It must be pointed out that the radiant ceiling remained active from 8:30 a.m. to 6:30 p.m., while during the hours in between only the ventilation with primary air was left on – again with an incoming air temperature neutral compared to the ambient temperature set point.



fig. 1.9 The meeting room used for the comfort level test

The measurements produced very interesting results as shown below:

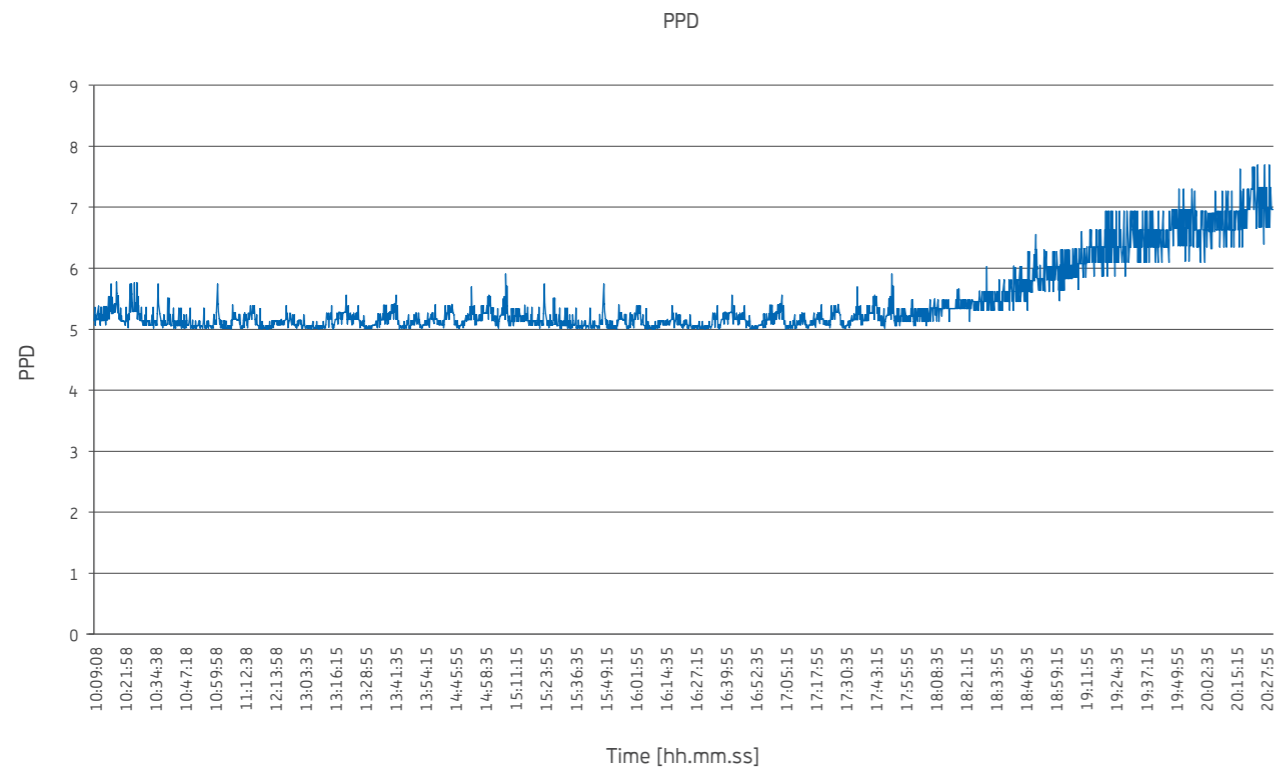

fig. 1.10 PPD tendency

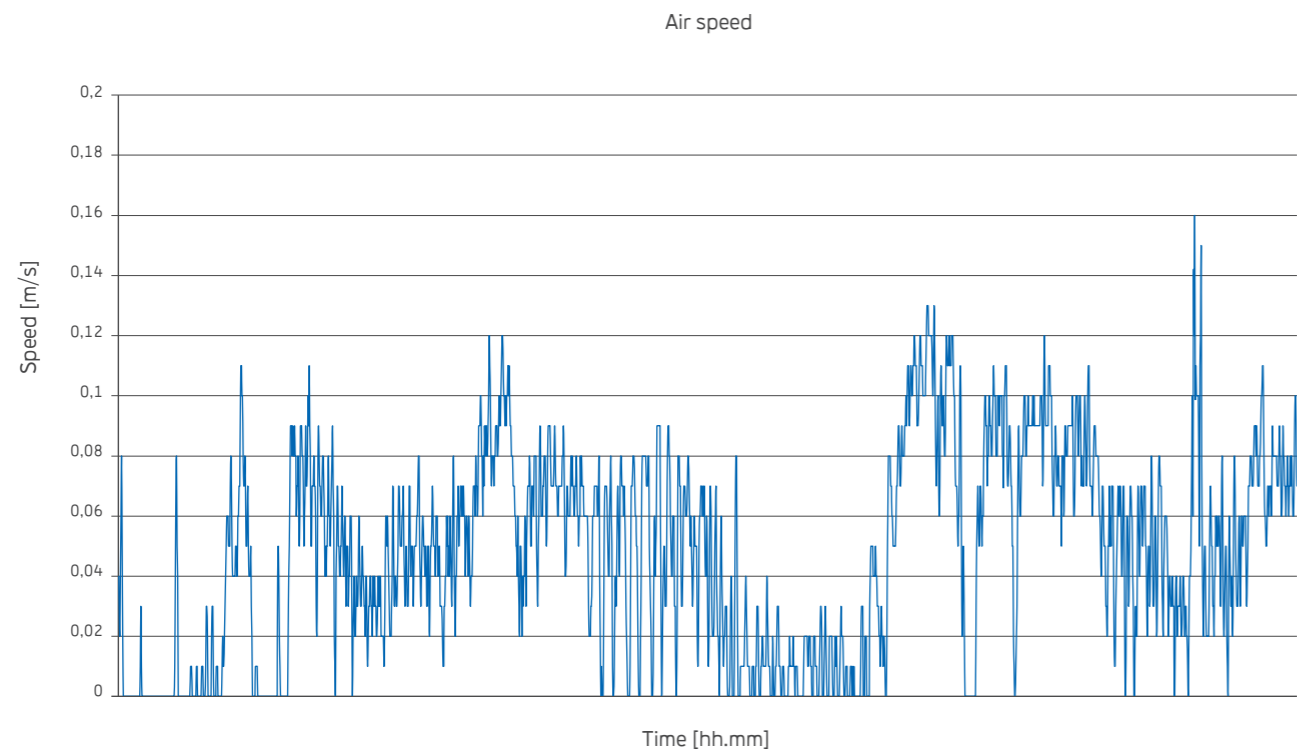

fig. 1.11 Air speed tendency

The PPD tendency clearly shows the level of comfort obtainable with radiant ceiling systems, as well as the progressive decrease of the comfort rate starting from 6:30 p.m., the time at which the system was shut down.

According to the recorded PPD, there is a reduced air speed in the space occupied by the individuals: the graphic is practically below 0.1 m/s, except for the peaks caused by individuals moving near the extremely sensible instruments.

This is an extraordinary result when considering the air low introduced in the ambient and – as proven by the room image – the apparent absence of air diffusion terminals.

The use of a micro-perforated ceiling panel as means to introduce air enabled to enhance the installation quality, as it improved sound absorption and reduced the air speed in the occupied area. As little as 0.25 m/s would have been a great result with a traditional system.

Mock-up test: from the comfort theory to the final project

The second example is an in-depth analysis carried out in the test room to identify the most suitable radiant panel in terms of target comfort for an office with a window subject to direct solar irradiation and characterized by ventilation introduced near the window itself.

It is an installation planning example with comfort limits.

The realization of model ambients and resorting of experimental test simulations are key to select the most suitable solution among the available options.

The image below shows the testing ambient setup. The temperature target is set at 24 °C.

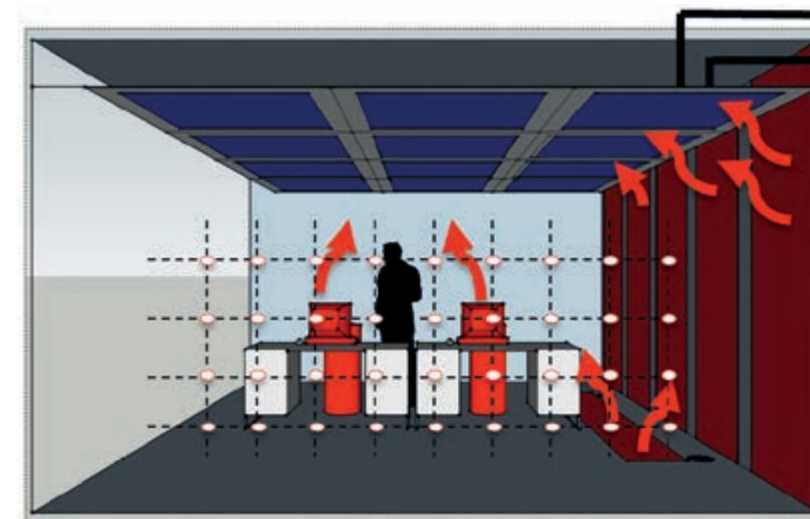

fig. 1.12 Representation of the office and cooling testing conditions.

All the following measurements show the main physical dimensions in different points of the so-called "occupied zone". As shown, the results are excellent.

NOTES
 * According to EN13779

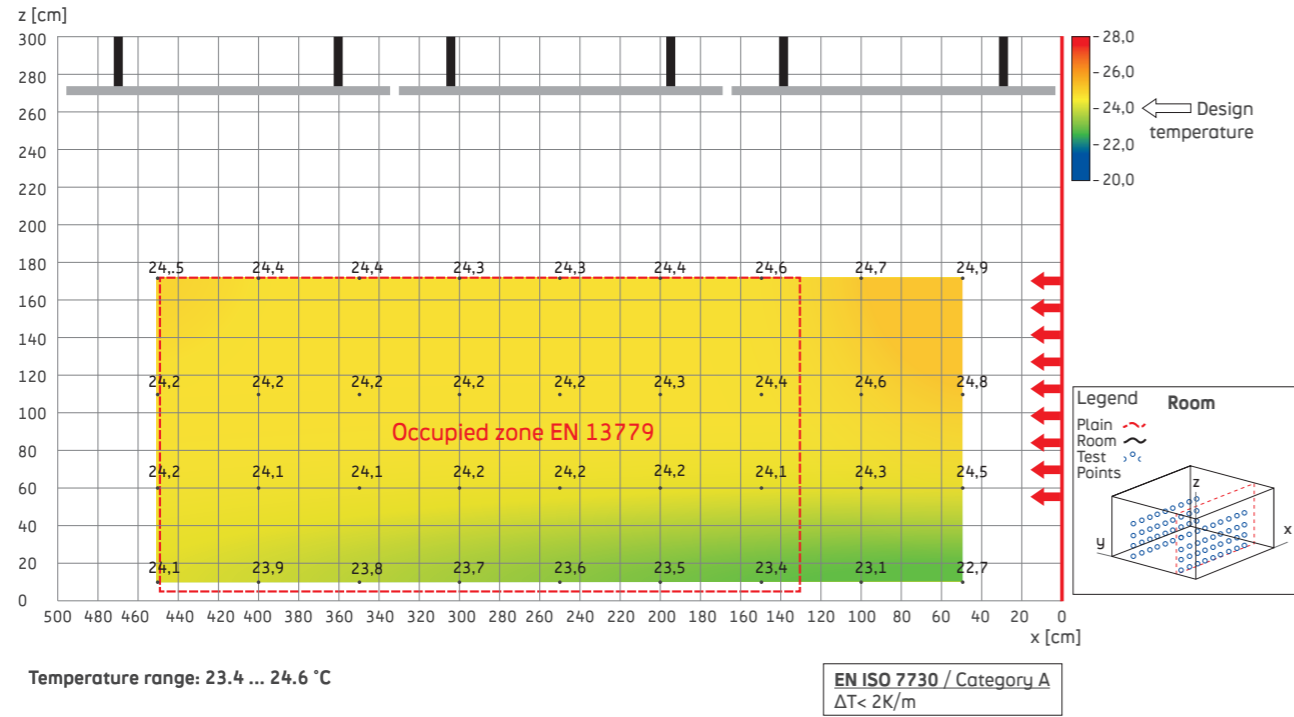

fig. 1.13 Temperature distribution - cooling

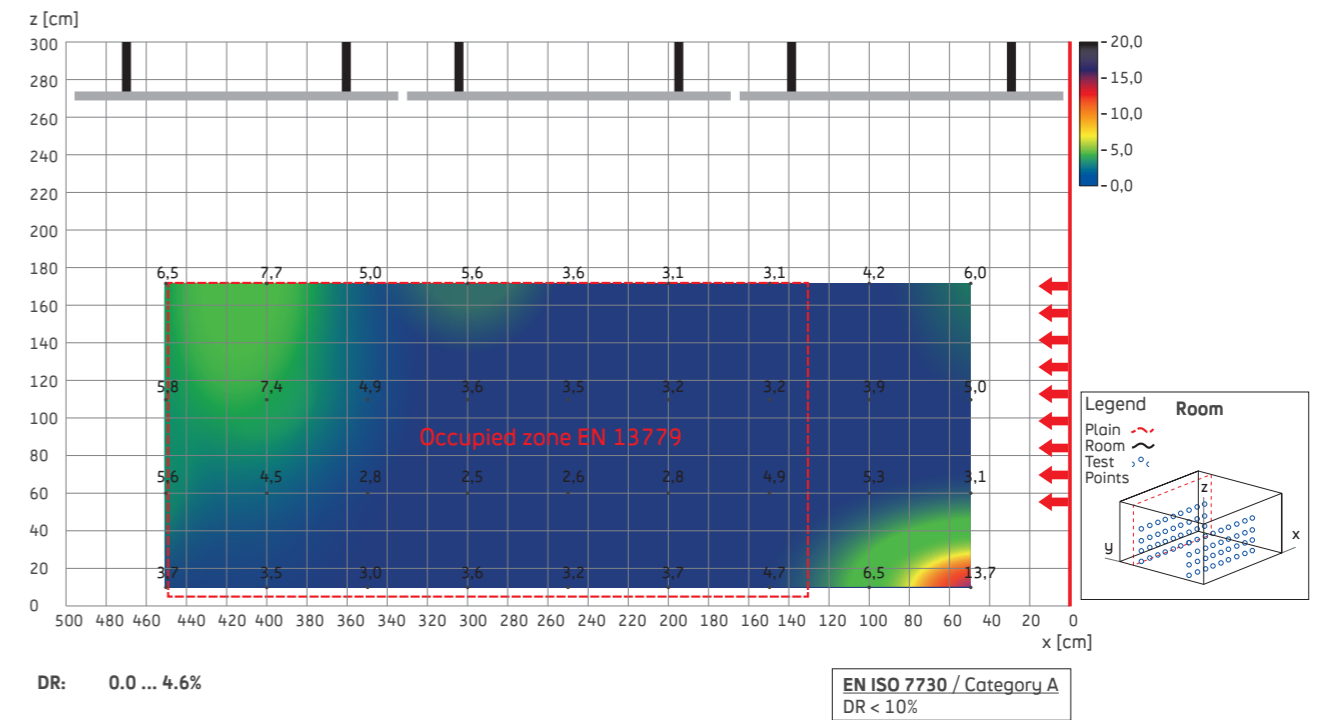

fig. 1.15 Draught Rate - air currents

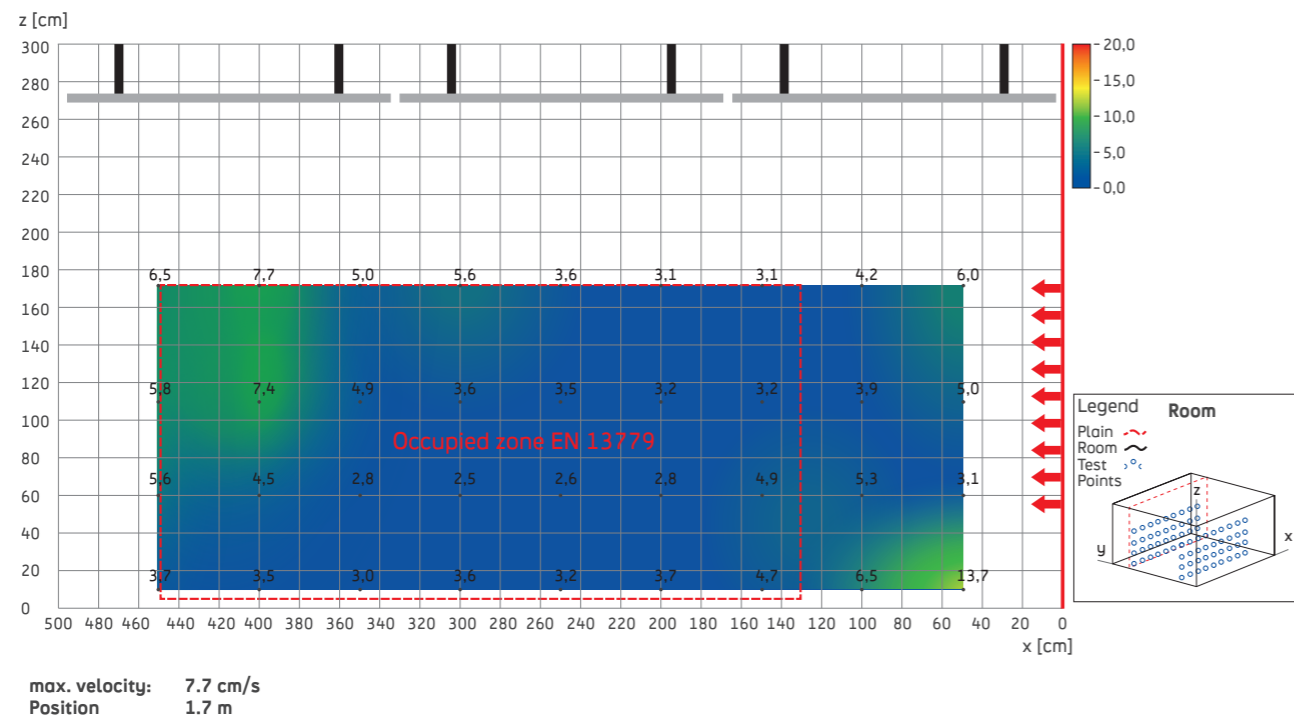

fig. 1.14 Air speed tendency

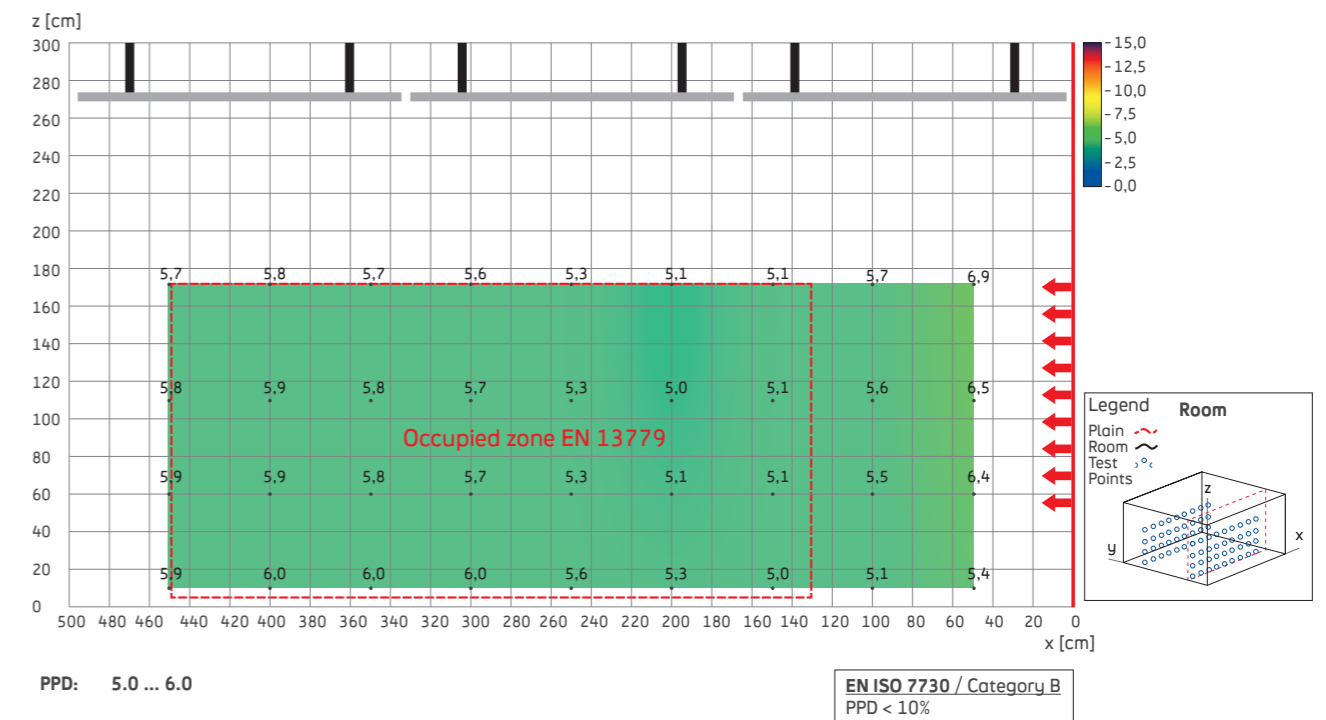

fig. 1.16 PPD - cooling

The heating test has led to very similar results. Below the air temperature distributions (set point 21 °C) and the PPD are the only shown.

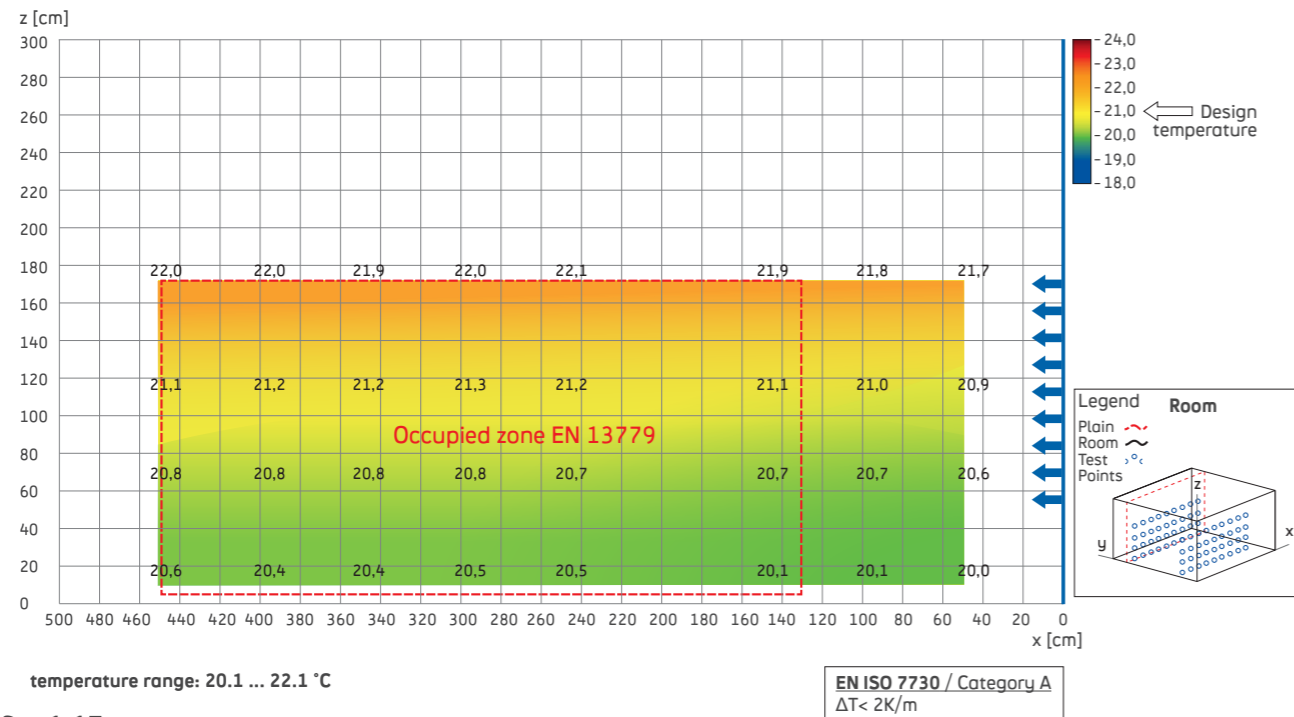

fig. 1.17 Temperature distribution – heating

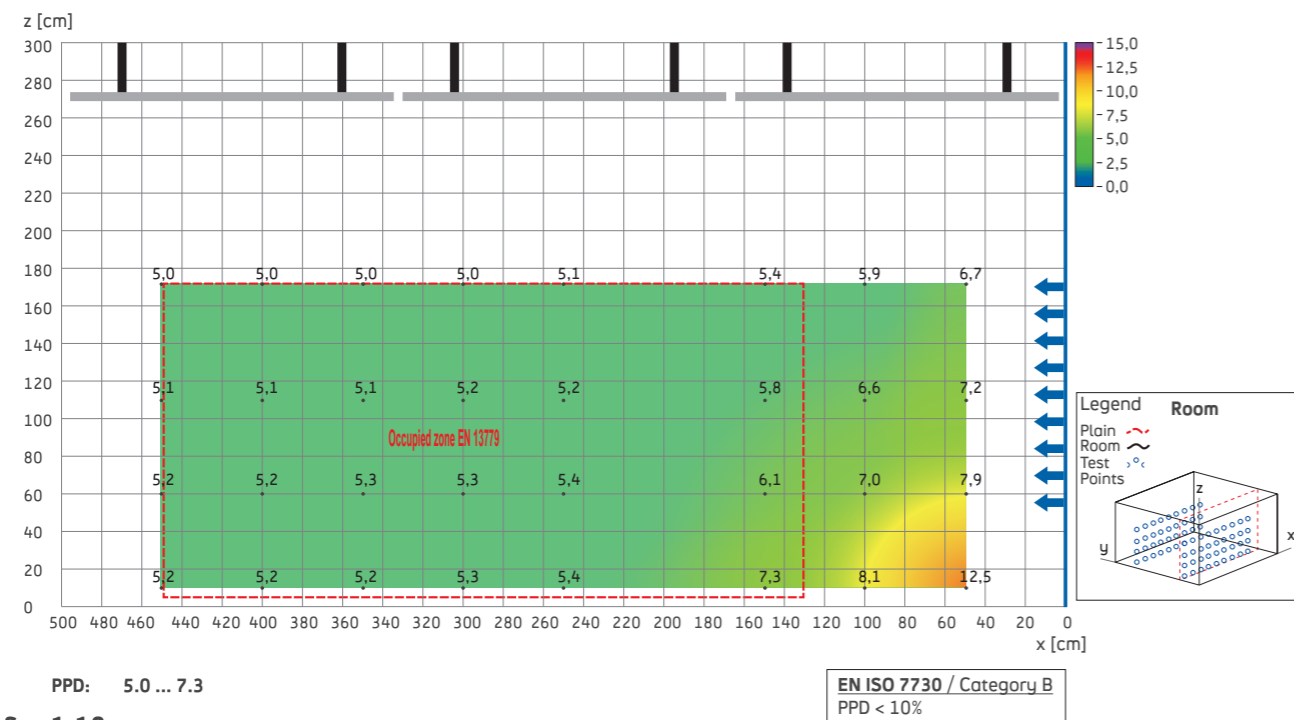

fig. 1.18 PPD –heating

If we compare the results of all these experimental analyses, it is clear that different applications provide the same levels of comfort thanks to the resourcefulness of radiant ceiling systems.

Modularity and flexibility

The simple fact that radiant ceilings represent an important resource in terms of energy saving while offering top comfort levels and space availability no doubt deserves great attention.

There is however another crucial feature that makes radiant heating and cooling systems worth great appreciation: they provide designers with more possibilities to interpret space and set the basis for flexible planning.

Thanks to the wide range of panel versions and dimensions, the most demanding architectural and installation needs can be fulfilled.

Rapid installation

The support structure components are assembled with preset bolts or joints for a rapid and accurate installation. Connection to the distribution manifolds includes rapid joints and plastic pipes, or special preassembled kits that make the entire intervention extremely easy and reliable.

In-house preassembly

Panels are preassembled in-house for an extremely easy and rapid installation.

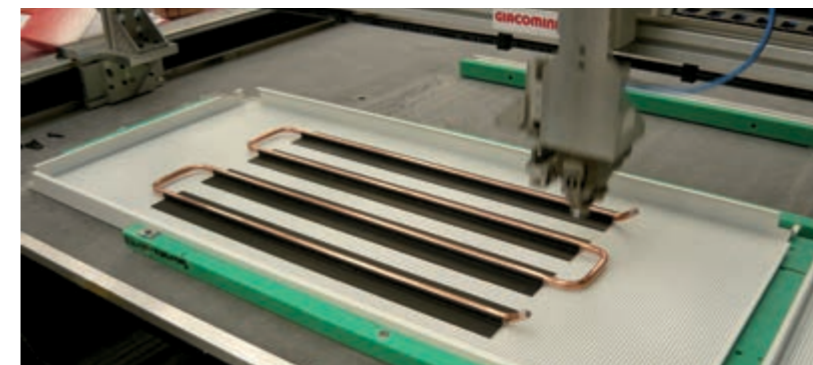

fig. 1.19 In-house assembly of radiant panels

Inspectionability

One of the most beneficial characteristics of metal radiant ceilings is their inspectionability. Inspecting the false ceiling or work in the space above, without turning off the system, is extremely practical, easy and safe.

In fact, access to the false ceiling and the systems inside, modification or maintenance of electric, computer-based, lighting, sound and other installations is very comfortable.

All these interventions can be performed in a targeted and selective way.

Inspectionability of the distribution manifolds through a special and practical trapdoor is guaranteed for the versions with plasterboard panels.

TYPES OF RADIANT CEILINGS

Giacomini's wide range of radiant ceiling systems can satisfy the most varied project and installation requirements which characterize the application field.

The entire family of radiant ceiling systems is developed into two product classes:

- > **metal-finish panels**, mostly suitable for hospitals and commercial buildings in general
- > **plasterboard-finish panels**, particularly indicated for residential buildings.

The next two chapters describe in depth all the radiant ceiling systems by Giacomini to better guide professionals in identifying the most suitable solution according to their needs.



The modern commercial sector: real architectural freedom, total surface and building volume valorization, maximum healthiness and top comfort. And last, but not least, tangible energy saving.

Chapter 2

Metal radiant ceilings

INTRODUCTION

The metal radiant ceilings class consists of two basic solutions; the table below shows them in detail:

series	model	modularity [mm x mm]	activation
GK	GK60	600x1200	C75 - A220
	GK120	1200x1200	C75 - A220
GK PSV	GK60x60 PSV	600x1200	C75 - A220
	GK60x120 PSV	600x1200	C75 - A220

Before analyzing each metal radiant ceiling system, it is advisable to describe the system core.

GK AND GK PSV PANEL TYPES

Metal panels can be active or inactive. Active panels provide radiant thermal exchange based on an integrated activation system while inactive panels have obviously only an aesthetic function.

Both panels are made with galvanized steel and are available smooth or micro-perforated; the standard R2516 micro perforation features a 2.5 mm hole on the entire panel surface, with the exception of a 15 mm wide band along the entire perimeter. The perforation percentage is equal to 16%, that is 16% of the panel surface is made by holes. Other types of perforation are available on request.

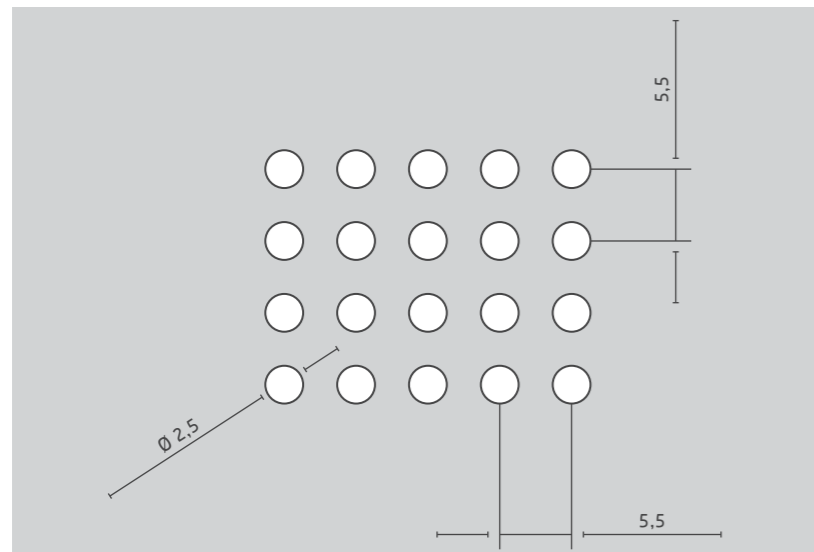

fig. 2.2 R2516 metal panel micro-perforation

fig. 2.1
Types of metal radiant ceilings

THE ACTIVATION SYSTEM

Metal radiant panels are available with two different activation systems, each suitable for specific application fields. The product technical specification sheets better describe in details every type of activation for every single panel, but here we will consider the GK60 panel as a model to illustrate the nature of the two options.

TYPE A ACTIVATION

Thermal exchange in panels featuring the A220 activation are made by a 16x1.5 mm plastic pipe with anti-oxygen barrier combined to a pair of 220x700 mm anodized aluminium diffusers. The panel-thermal exchange system group is pre-assembled in-house.

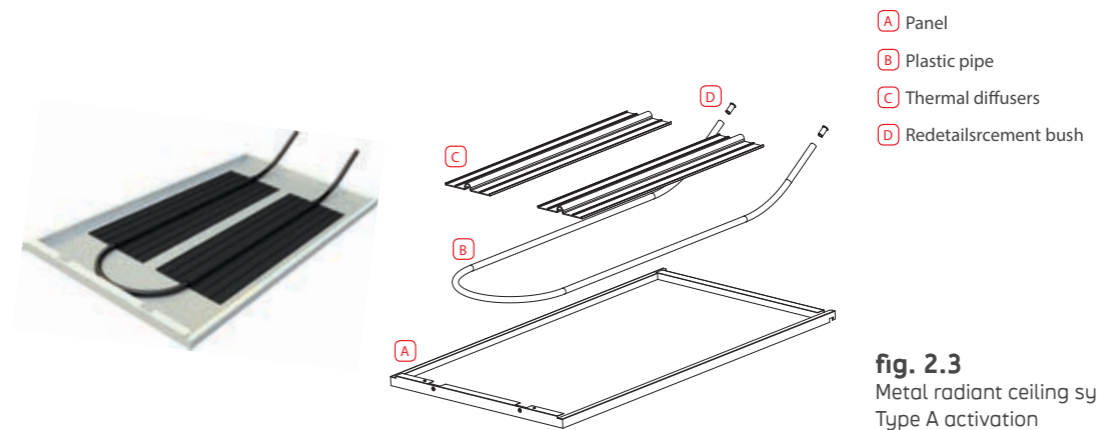

fig. 2.3
Metal radiant ceiling system:
Type A activation

TYPE C ACTIVATION

Thermal exchange in panels featuring the C75 activation are made by a hydraulic circuit realized with a 12x1 mm copper coil combined to a group of four 75x100 mm anodized aluminium diffusers. The panel-thermal exchange system group is pre-assembled in-house.

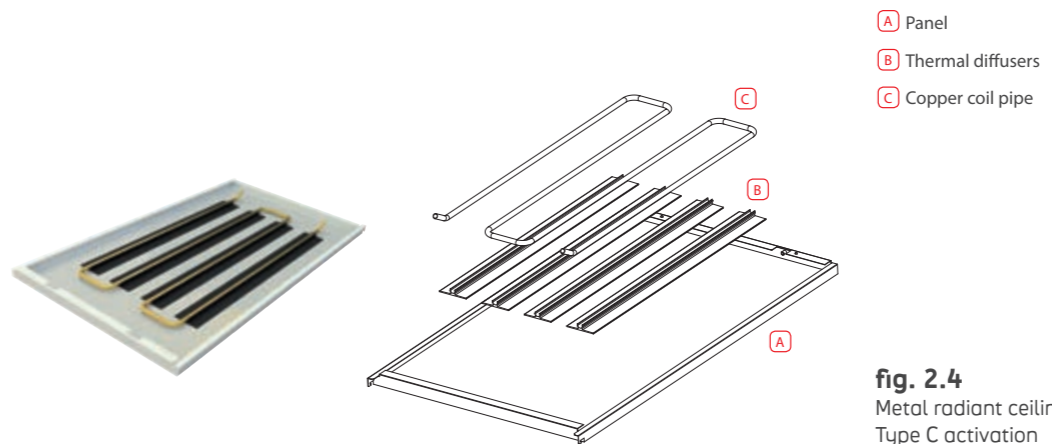

fig. 2.4
Metal radiant ceiling system:
Type C activation

GK120 SYSTEM METAL RADIANT PANELS

WHY GK120

- particularly indicated for open-space ambients
- easy installation of lighting elements in the structure
- availability of pre-cut panels and supports
- cross-pattern support structure
- fully inspectionable
- two activation systems
- customizable on request

more details on
giacomini.com

INTRODUCTION

GK120 is a metal radiant ceiling system particularly indicated for heating and cooling of open-space ambients such as offices, lounges, commercial spaces, airports, school buildings. Characterized by its 1200x1200 mm modularity, GK20 provides for installation of a cross-pattern support structure which embeds each panel completely.

The hanging system is designed to offer the best false ceiling planarity.

Panels can be micro-perforated or smooth. Side compensation is generally made with plasterboard.

PANEL TYPES

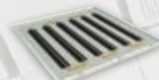

K120C Micro-perforated
> Modularity: 1200x1200 mm
> Activation: copper



K120LC Smooth
> Modularity: 1200x1200 mm
> Activation: copper

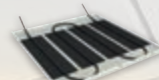

K120A Micro-perforated
> Modularity: 1200x1200 mm
> Activation: plastic

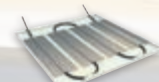

K120LA Smooth
> Modularity: 1200x1200 mm
> Activation: plastic

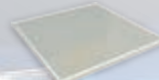

K120 Micro-perforated
> Modularity: 1200x1200 mm
> Inactive



GK120 SYSTEM METAL RADIANT PANELS



- > Galvanized steel panel, 8/10 thickness, 1030x1030 mm
- > R2516 micro-perforated or smooth panel
- > Installation on exposed cross-pattern support structure, with 150 mm base support
- > Rotation opening system
- > Closing with sealing springs
- > Aluminium diffuser activation and copper coil – C75 or plastic – A 220
- > Basic colours: RAL9010 - white RAL9006 - silver. Other colours available on request
- > 1200x1200 mm false ceiling module
- > Particularly indicated for open-space ambients
- > Possibility to install a thermoacoustic mat to enhance the system performance
- > Easy integration of lighting elements in the false ceiling thanks to panels and supports pre-cut in-house
- > Inspectionability system

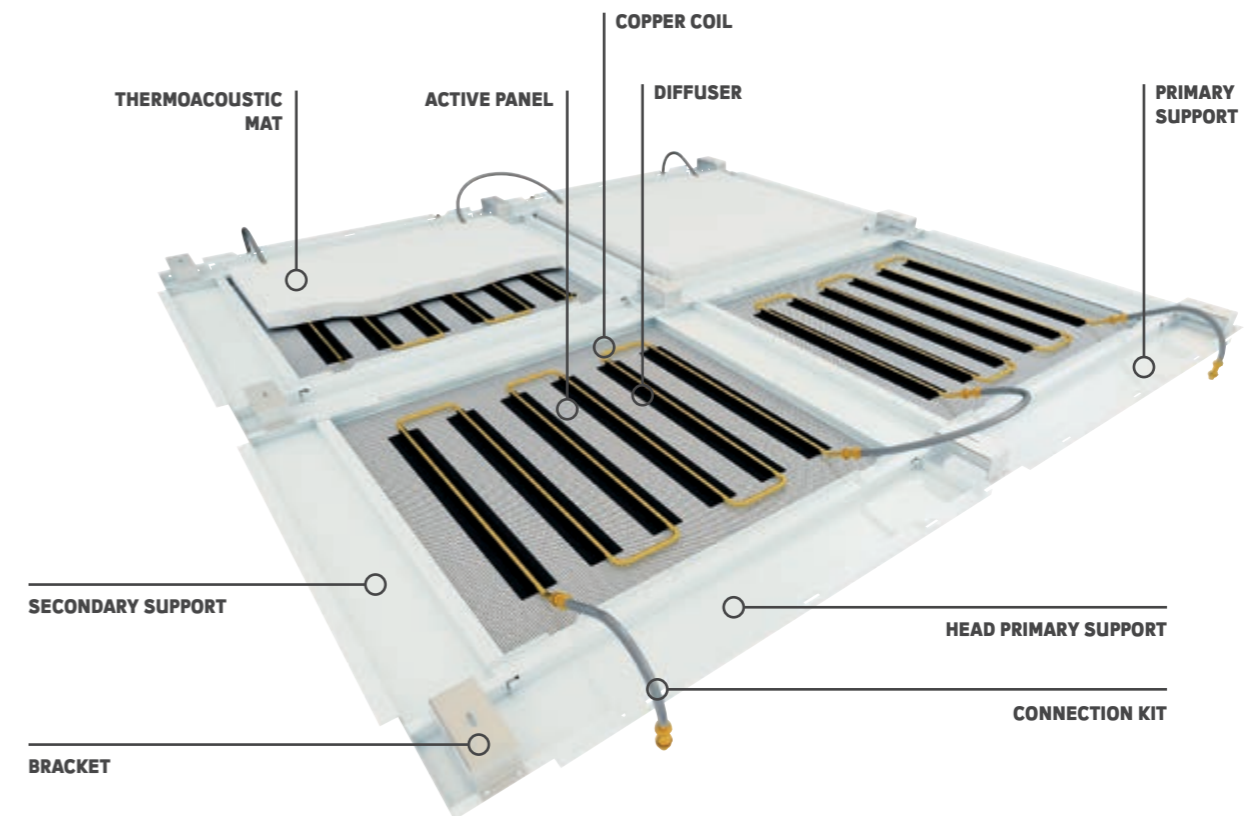

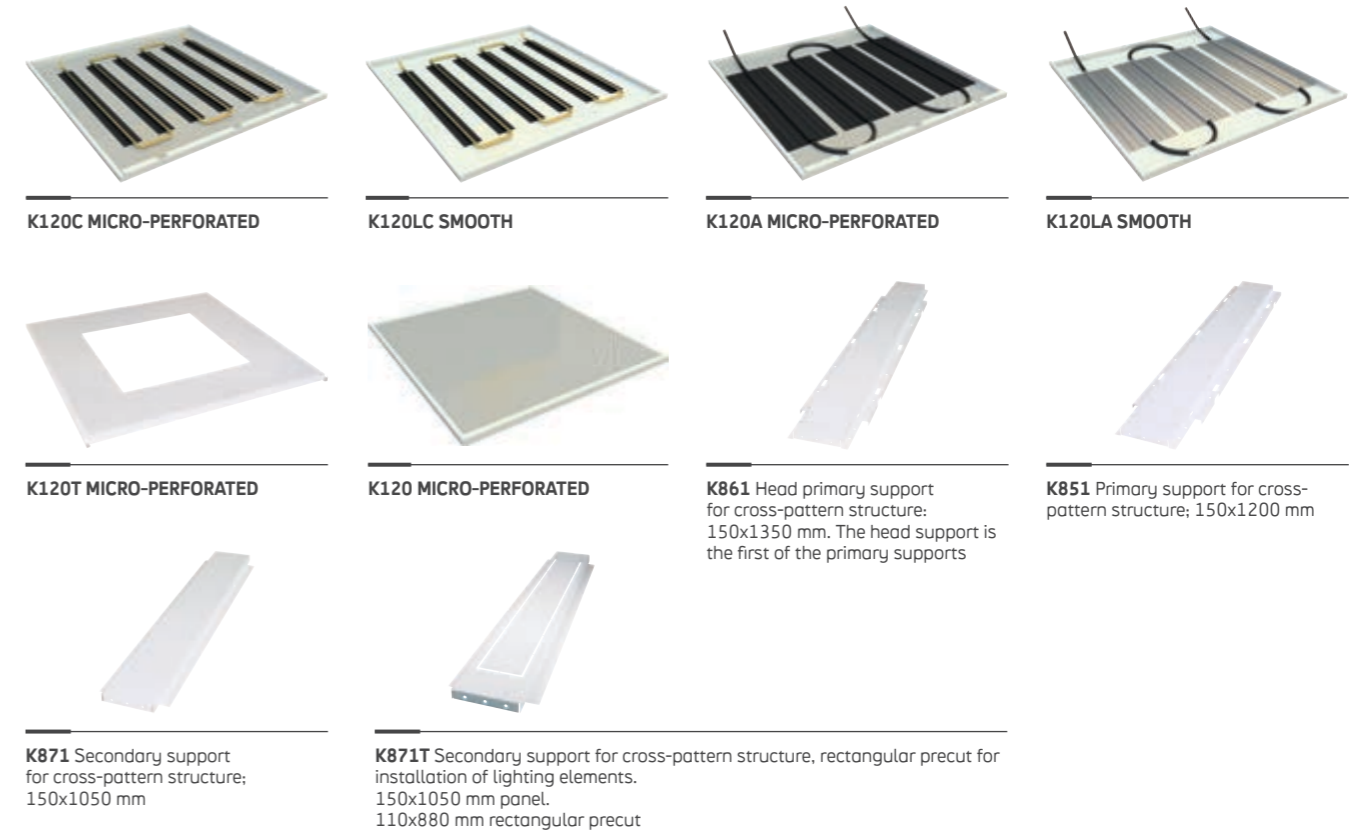

GK120 PANELS AND SUPPORTS

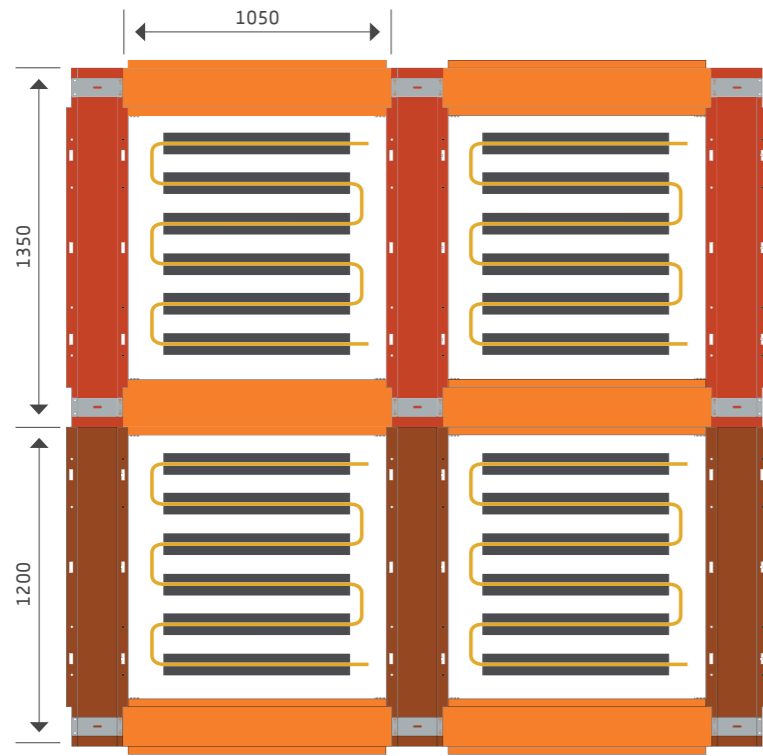

The system structure is shown in the plan and section view pictures below:



SUPPORTS

-  **K861:** 150x1350 mm head primary support
-  **K851:** 150x1200 mm primary support
-  **K871:** 150x1050 mm secondary support

K120 PANELS

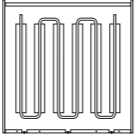
-  **K120 (inactive) or K120A/K120C (active):** 1030x1030 mm

The cross-pattern structure presents two rows of supports. The 150 mm primary supports, installed according parallel directrices with a to 1200 mm interdistance – represent the backbone of the false ceiling; transversally, and with the same 1200 mm interdistance are the secondary supports which complete and stiffen the system. A 10 mm shutter is installed between the supports and the panel to easily open the same.

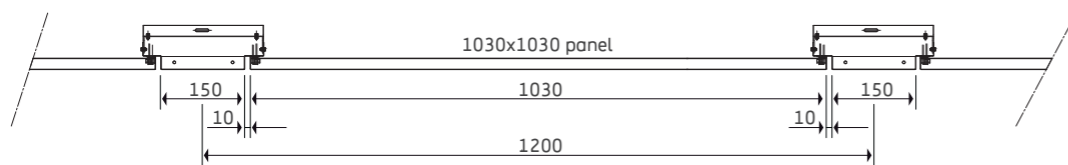









Section view of the GK120 system – cross-pattern structure and 150 mm base supports

APPLICATION EXAMPLES



CORRELATED PRODUCTS

			
Modular manifold	Manifold accessories	Manifold insulation	Pipe
			
Connection kits and/or fittings	System additive	Thermoregulation	Air treatment

GK60 SYSTEM

METAL RADIANT PANELS

WHY GK60

- indicated for small/medium open-space ambients
- availability of pre-cut panels for integration of lighting elements
- sturdy bearing structure made by supports and finishing heads
- parallel-laying support structure
- fully inspectionable
- two activation systems
- customizable on request

more details on
giacomini.com

INTRODUCTION

GK60 is an extremely versatile metal radiant ceiling. Suitable for heating and cooling of medium/small open-space ambients such as meeting rooms, offices, hospital rooms. It is characterized by a 600x1200 mm modularity and provides for the installation of parallel-laying support structures, completed by the installation of head elements.

The hanging system is designed to offer the best false ceiling planarity.

Panels can be micro-perforated or smooth. Side compensation is generally made with plasterboard.

PANEL TYPES



K60C Micro-perforated
> Modularity: 600x1200 mm
> Activation: copper



K60LC Smooth
> Modularity: 600x1200 mm
> Activation: copper

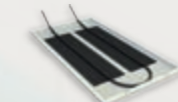

K60A Micro-perforated
> Modularity: 600x1200 mm
> Activation: plastic

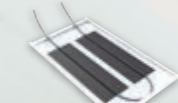

K60LA Smooth
> Modularity: 600x1200 mm
> Activation: plastic



K60 Micro-perforated
> Modularity: 600x1200 mm
> Inactive

GK60 SYSTEM METAL RADIANT PANELS



- > Galvanized steel sheet panel, 8/10 thickness, 596x1030 mm
- > R2516 micro-perforated or smooth panel
- > Installation on exposed parallel support structure, with 150 mm base support
- > Twist opening
- > Closing with sealing springs
- > Activation with aluminium diffusers and copper – C75 or plastic – A220 coil
- > Basic colours: RAL 9010 – white or RAL9006 – silver. Other colours available on request
- > 600x1200 mm false ceiling module
- > Particularly indicated for open-space ambients, but also for medium/small environments (meeting rooms, offices, hospital rooms)
- > Possibility to install a thermoacoustic mat to improve the system performance
- > Enhances the integration of lighting elements in the false ceiling thanks to in-house pre-cut panels and supports
- > Inspectionable system

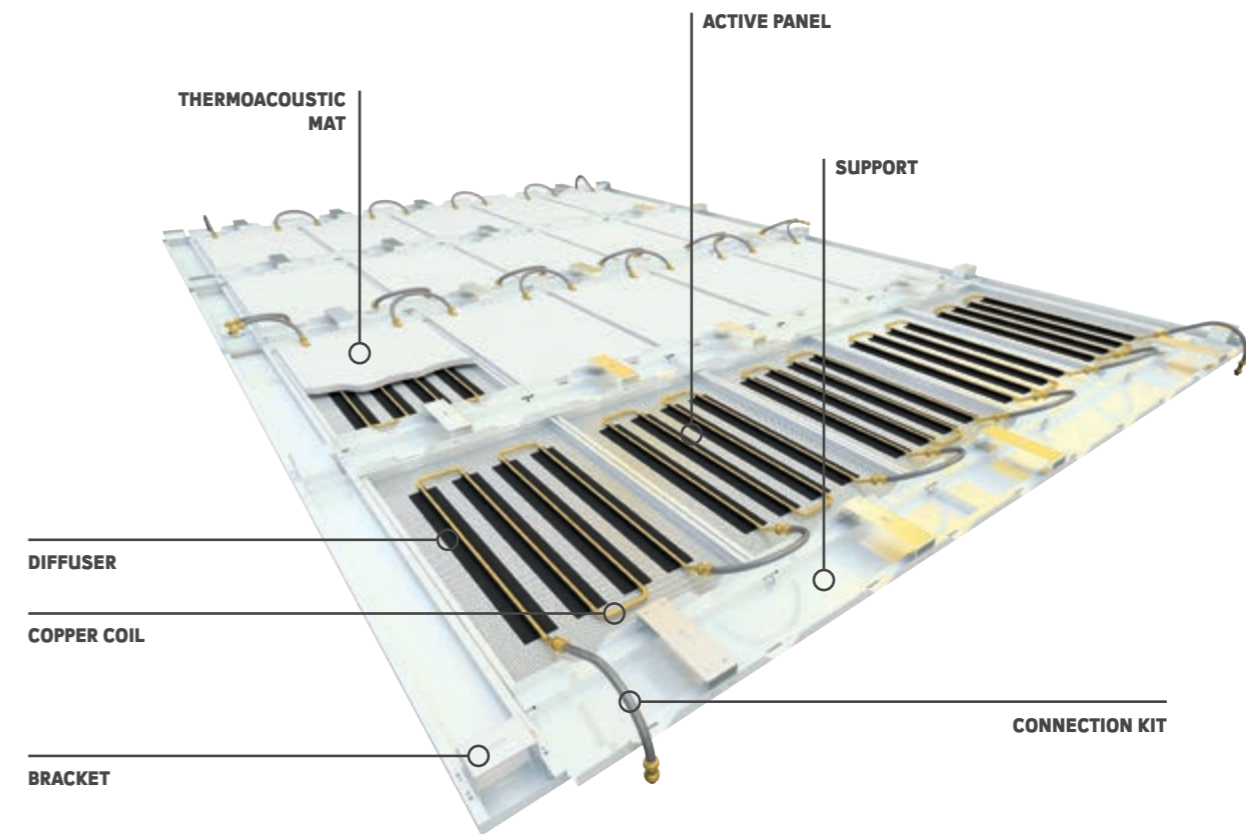

GK60 PANELS AND SUPPORTS

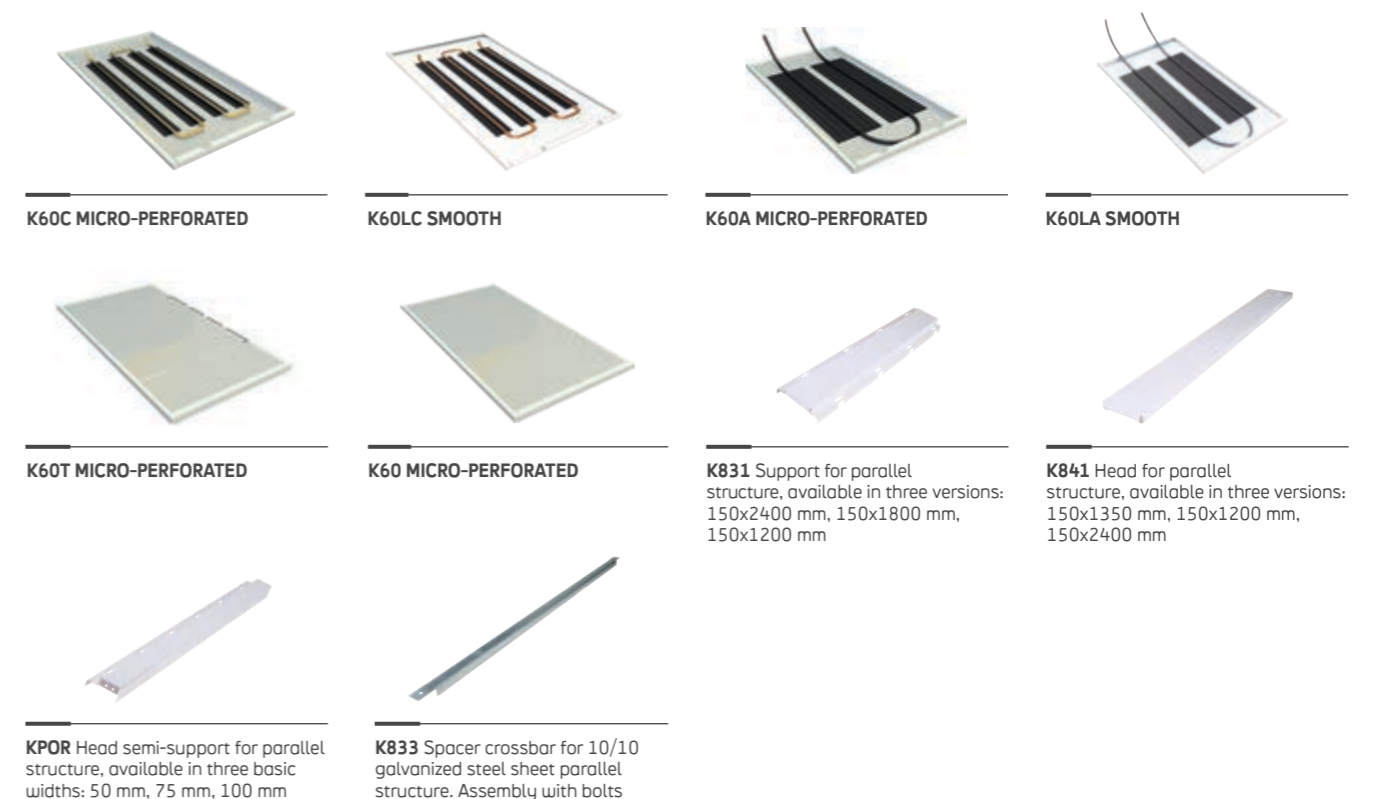

The system is structurally represented below with plan and section views:

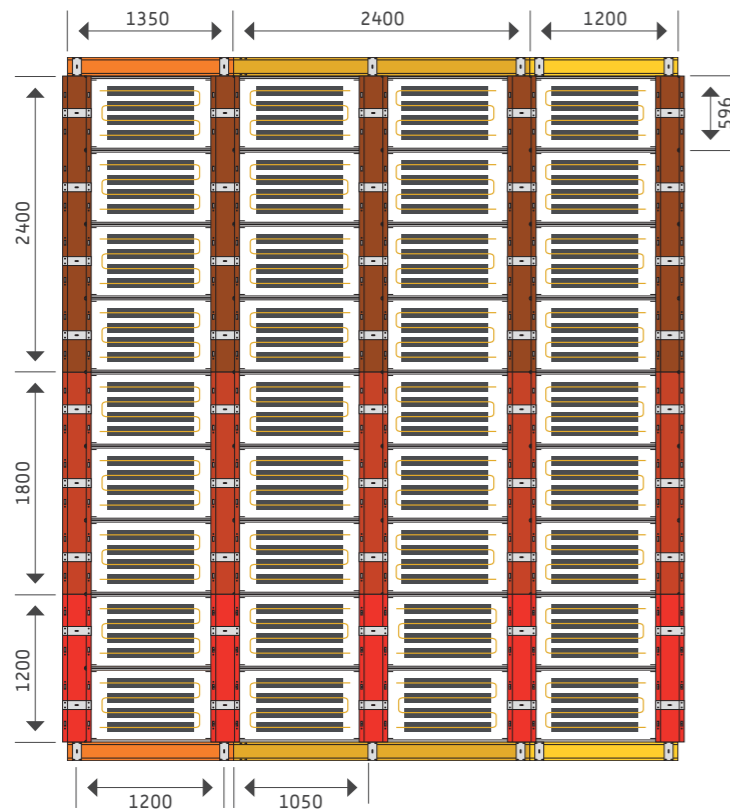

K831 SUPPORT

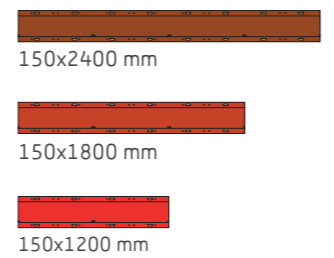

K841 HEADS

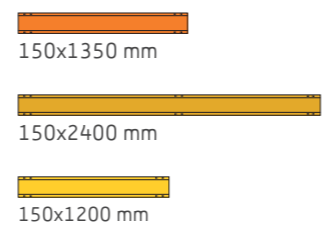

K160 PANELS

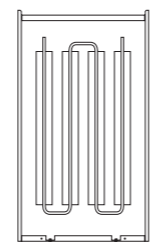

K60 (inactive) or **K60A/K600C** (active):
596x1030 mm

The structure features 150 mm-wide primary supports installed in parallel with 1200 mm center distance. Panels are positioned transversally. A head support completes the system. Between the support and the panel is installed a 10 mm shutter to allow for easy opening.

In case of space restrictions, semi-supports can be used in order to reduce overall dimensions and maximize space.

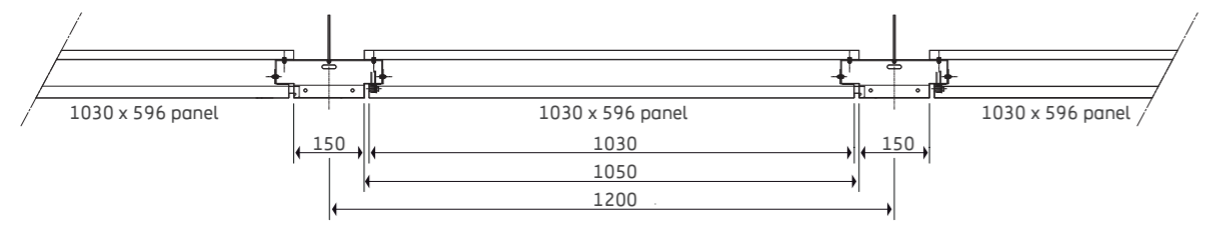









GK60 section view – 150 mm base parallel structure and supports

APPLICATION EXAMPLES



CORRELATED PRODUCTS

 Modular manifold	 Manifold accessories	 Manifold insulation	 Pipe
 Connection kits and/or fittings	 System additive	 Thermoregulation	 Air treatment

GK SYSTEM INSTALLATION AND INSPECTIONABILITY

INSTALLATION

The GK system assembly requires the same installation steps provided for traditional metal panel false ceilings.

First of all, set the brackets according to the project; then fit them to the supports: the cross-pattern structure requires K852 brackets for the primary supports and for head primary supports, while K832 brackets are required for the supports of parallel structures and K842 brackets for the heads. Brackets are fixed to the ceiling with K819 L-shaped plates and K818 slotted bars. Complete by levelling the supports.

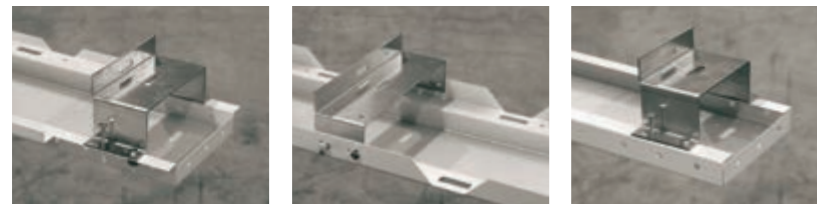

K852 bracket for primary supports

K832 bracket for parallel structure support

K842 bracket for parallel structure head

fig. 2.5
GK60 supports and brackets



K852 - 150x52x70
Bracket for 20/10 galvanized steel primary supports

K832 - 228x52x70
Bracket for 20/10 galvanized steel parallel support structure

K842 - 110x52x70
Bracket for 20/10 galvanized steel parallel head structure

K819 - 50x95
Galvanized steel sheet L-shaped plate for slotted bar

K818 - 25x10
Slotted bar for installation of galvanized steel sheet structures

Series GK120 requires the installation of secondary supports every 120 cm. Series GK60 requires K833 spacer crossbars to set the distance between the supports and enhance the sturdiness of the support structure.

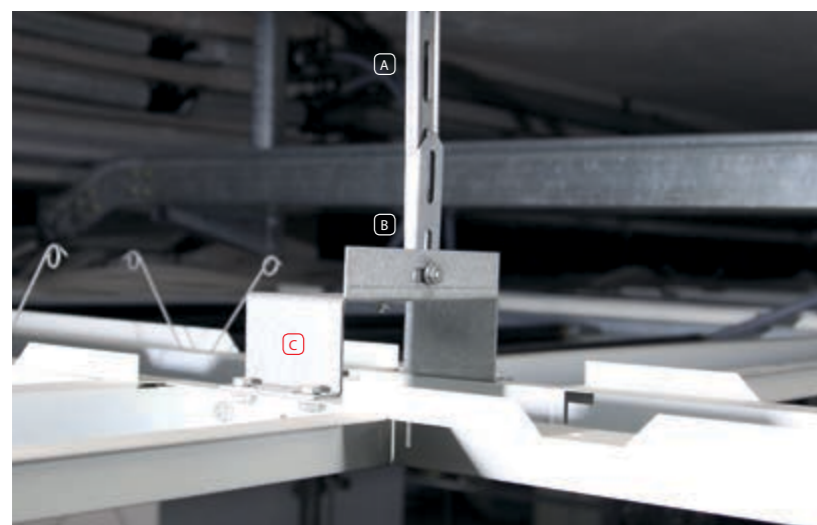

A Slotted bar
B L-shaped plates
C Bracket

fig. 2.6
Bracketing detail of a GK120 radiant false ceiling

Each bracket is fixed to the supports with bolts. Once the structure has been assembled, the springs are fitted on panels as shown below. The panels can then be installed and the rotation direction can be set according to the project.

The panels are anchored by their hooks in the corresponding support slots and positioned vertically and then the hydraulic connections are carried out by carefully following the installation project instructions.

Panels which are part of the same circuit are connected one to the other while the first and last panel of the series are connected to their distribution manifold – one for delivery and the other for return. Finally, the false ceiling is closed by rotating the panels and using the special fitting springs.



The panel is secured by the safety springs and once unhooked it can be placed vertically.

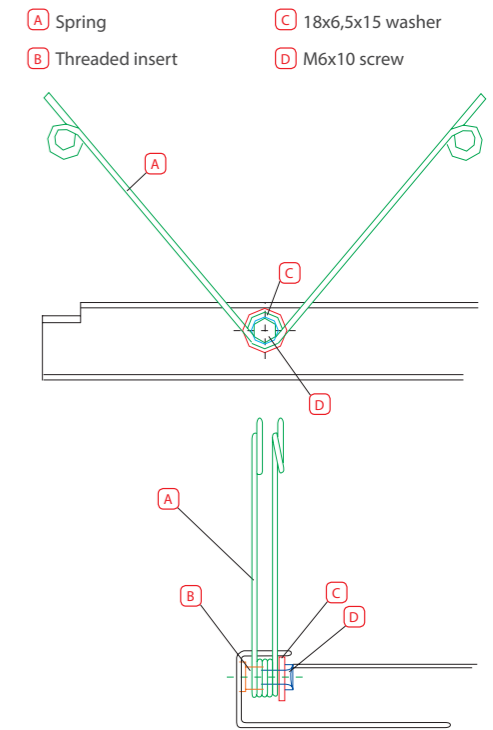

fig. 2.7 GK fitting springs

INSPECTIONABILITY

Each GK panel features two hooks fitted into the special support slots; around the panel can pivot by 90° around the hooks to reach the vertical position. This enables to easily access the false ceiling for inspection, even when the system is turned on. Special safety springs keep the panel in place and allow to open and close it.

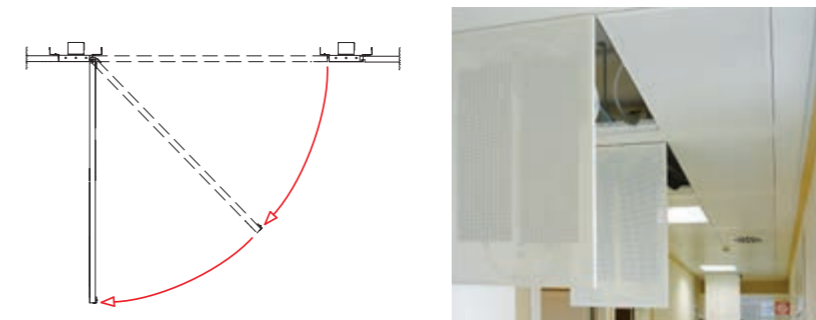

fig. 2.8
Inspectionability of the GK radiant false ceiling:
The panels hang from the supports

SYSTEM **GK60x120 PSV** METAL RADIANT PANELS

WHY GK60x120

- indicated for any kind of ambient
 - T24 cross-pattern support structure T24
 - rapid installation
 - fully inspectionable
 - two activation systems
 - customizable on request
- more details on giacomini.com

INTRODUCTION

GK60x120 PSV is a metal radiant ceiling for heating and cooling of medium-sized commercial ambients.

Characterized by a 600x1200 mm modularity, this system requires the installation of an exposed cross-pattern support structure with 24 mm T-shaped base supports.

The hanging system is designed to offer the best false ceiling planarity.

Panels can be micro-perforated or smooth. Side compensation is generally made with plasterboard or cut to size passive panels.

PANEL TYPES



K12C Micro-perforated
> Modularity: 600x1200 mm
> Activation: copper



K12LC Smooth
> Modularity: 600x1200 mm
> Activation: copper



K12A Micro-perforated
> Modularity: 600x1200 mm
> Activation: plastic

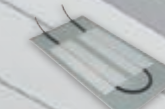

K12LA Smooth
> Modularity: 600x1200 mm
> Activation: plastic



K12 Micro-perforated
> Modularity: 600x1200 mm
> Inactive



K12L Smooth
> Modularity: 600x1200 mm
> Inactive

SYSTEM GK60x120 PSV METAL RADIANT PANELS

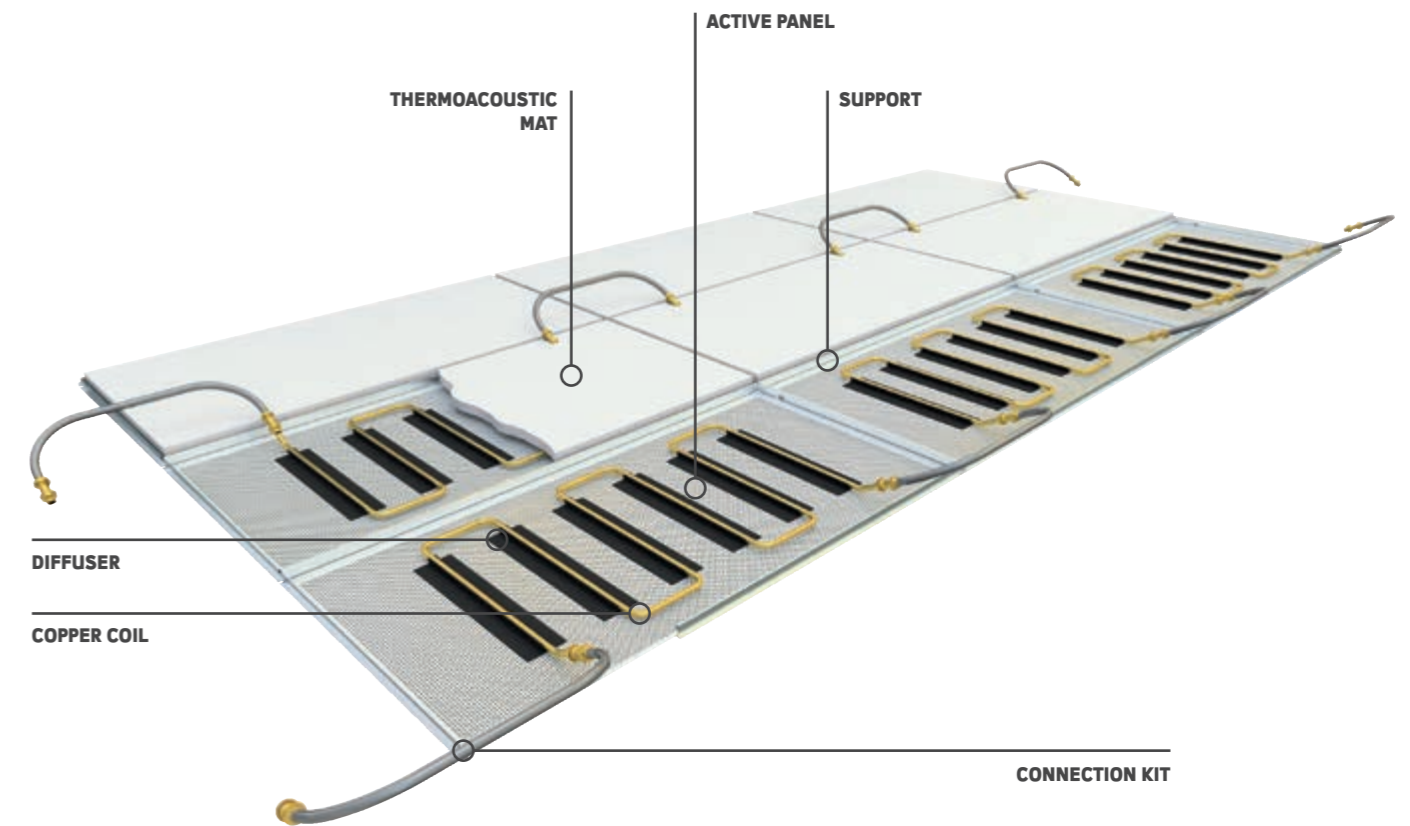

- > Galvanized steel sheet panel, 6/10 thickness, 575x1175 mm
- > R2516 micro-perforated or smooth panel
- > Installation on exposed lightweight support structure - reverse T-shaped - with 244 mm base supports
- > Opening and suspension with steel wires
- > Quick-lock installation, no need to use nuts and bolts to fit the elements.
- > Activation with aluminium diffusers and copper- C75 or plastic – A220 coil
- > Basic colours: RAL9003 – white, or RAL9006 – silver. Other colours available on request
- > 600x1200 mm false ceiling module
- > Indicated for medium and large ambients
- > Possibility to install a thermoacoustic mat to enhance the system performance
- > The use of standardized components and dimensions offers additional benefits: market availability and easy installation of all accessories, such as lighting elements, air diffusers and any other false ceiling element.
- > Inspectionable system

GK60X120 PSV PANELS AND SUPPORTS

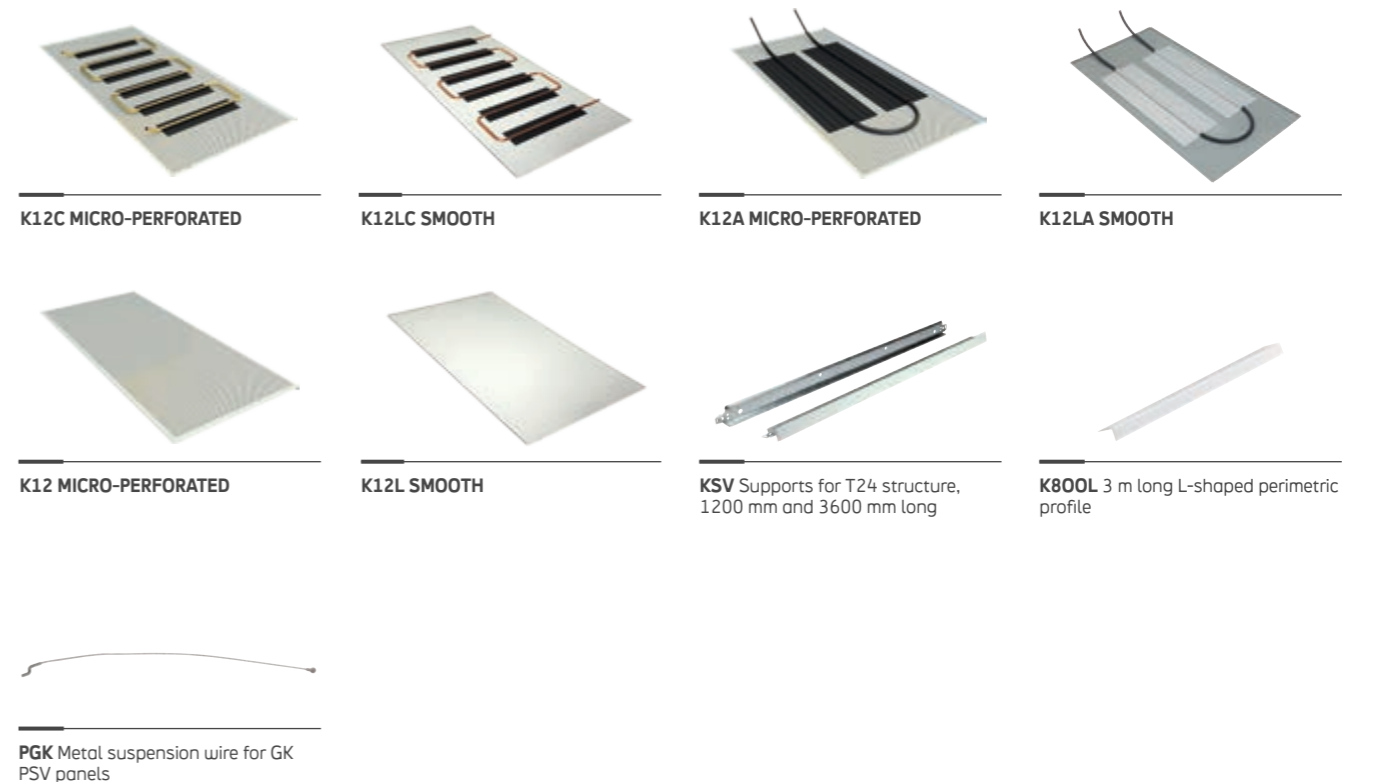

The system is structurally represented below with plan and section views:

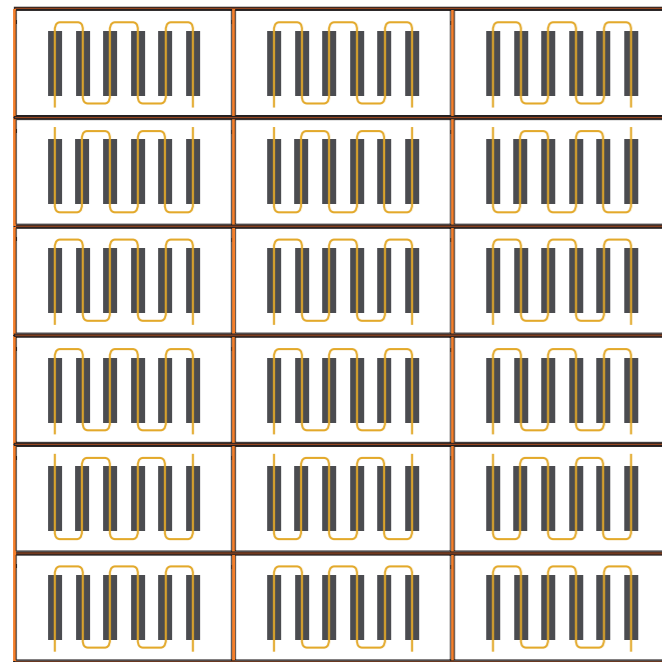

SUPPORT AND PANELS

KSV36X 24 mm L=3600 mm base supports

KSV6X 24 mm L=600 mm base supports

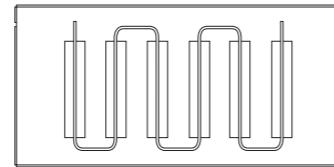

K12C or **K12A** 575x1175 mm active panel

PANEL SUSPENSION



Exposed reversed T-shaped support with 24 mm base supports. This standard structure is lightweight, with a wide diffusion range and is generally used with ordinary false ceilings. The main supports are suspended with a typical spring+hanger system, widespread for false ceiling installations.

The side finishes can include passive panels, possibly cut to size, or as an alternative, plasterboard which is used more frequently and offers greater design freedom.

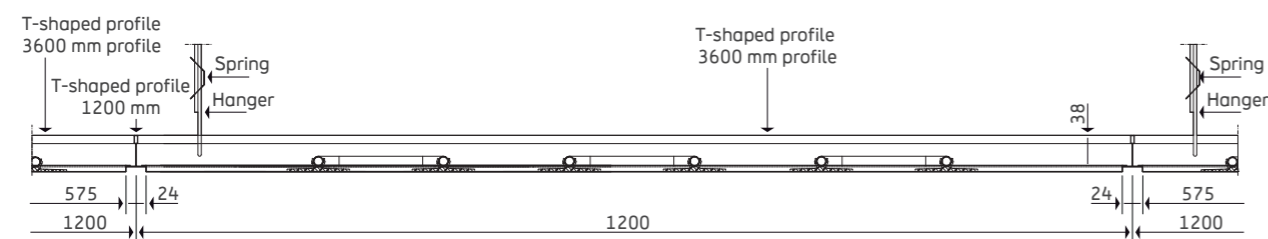

GK60x120 PSV 24 mm base T-shaped structure section

APPLICATION EXAMPLES



CORRELATED PRODUCTS

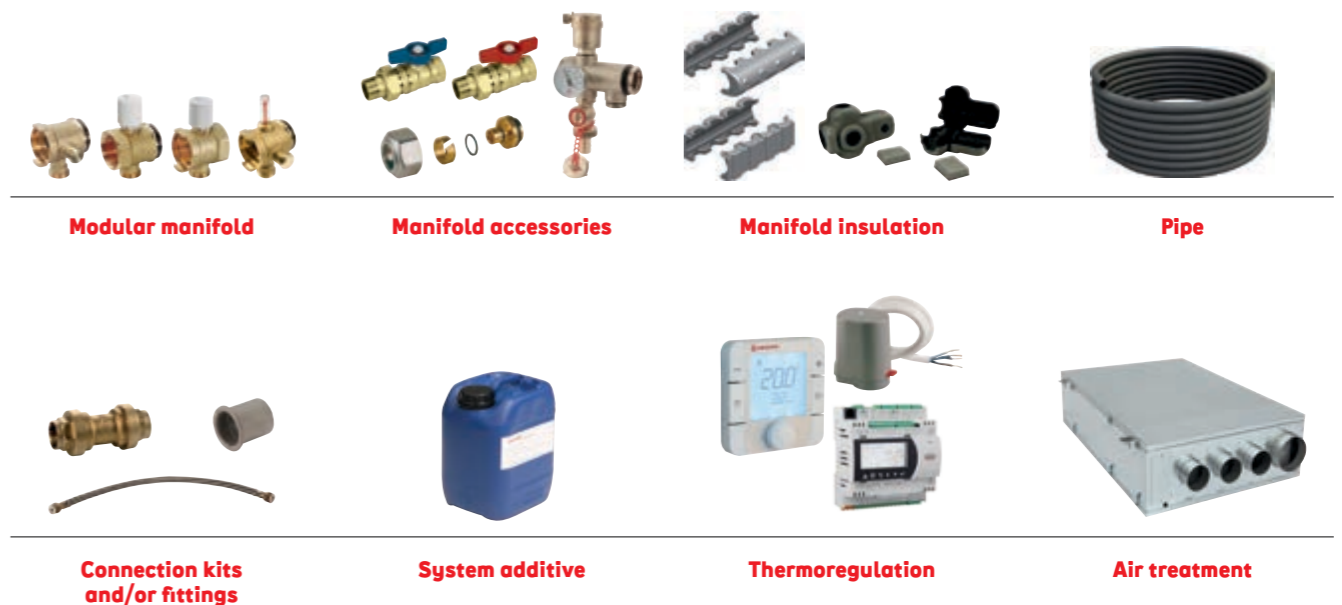

Modular manifold

Manifold accessories

Manifold insulation

Pipe

Connection kits and/or fittings

System additive

Thermoregulation

Air treatment

GK60x60 PSV SYSTEM METAL RADIANT PANELS

WHY GK60x60

- indicated for any kind of ambient
- T24 cross-pattern support structure type T24
- rapid installation
- fully inspectionable
- two activation systems
- enables to balance the most severe thermal loads
- customizable on request

more details on
giacomini.com

INTRODUCTION

GK60x60 PSV represents the most suitable metal radiant ceiling for commercial solutions. Perfect to heat and cool medium/small ambients, yet proving its versatility at best when integrated in large open-space environments.

Characterized by a 600x600 mm modularity, this system requires the installation of an exposed cross-pattern support structure, with 24 mm base T-shaped supports.

The hanging system is designed to offer the best false ceiling planarity.

Panels can be micro-perforated or smooth. Side compensation is generally made with plasterboard. Side compensation is generally made with plasterboard or cut to size passive panels.

PANEL TYPES



K6C Micro-perforated
> Modularity 600x600 mm
> Activation: copper



K6LC Smooth
> Modularity 600x600 mm
> Activation: copper

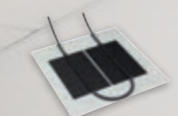

K6A Micro-perforated
> Modularity 600x600 mm
> Activation: plastic



K6LA Smooth
> Modularity 600x600 mm
> Activation: plastic



K6 Micro-perforated
> Modularity 600x600 mm
> Inactive



K6L Smooth
> Modularity 600x600 mm
> Inactive



GIUSO



GK60x60 PSV SYSTEM METAL RADIANT PANELS



- > Galvanized sheet steel panel, 6/10 thickness, 575x575 mm
- > R2516 micro-perforated or smooth panel
- > Installation on exposed lightweight reversed T-shaped support structure with 244 mm base supports
- > Opening and suspension with steel wires
- > Quick-lock installation: no need to use nuts and bolts to fit the elements
- > Activation with aluminium diffusers and copper – C75 or in plastic – A220 coil
- > Basic colours: RAL9003 – white or RAL9006 – silver. Other colours available on request
- > 600x600 mm false ceiling module
- > Indicated for all kinds of ambients, this system performs at its best in small or irregular spaces thanks to its space-saving modularity and minimum overall dimensions of the support structure. In such cases, it is the best system guaranteeing the best thermal performance
- > Possibility to install a thermoacoustic mat to increase the system performance
- > The use of standardized components offers additional benefits: market availability and easy installation of all accessories, such as lighting elements, air diffusers and any other false ceiling element
- > Inspectionable system

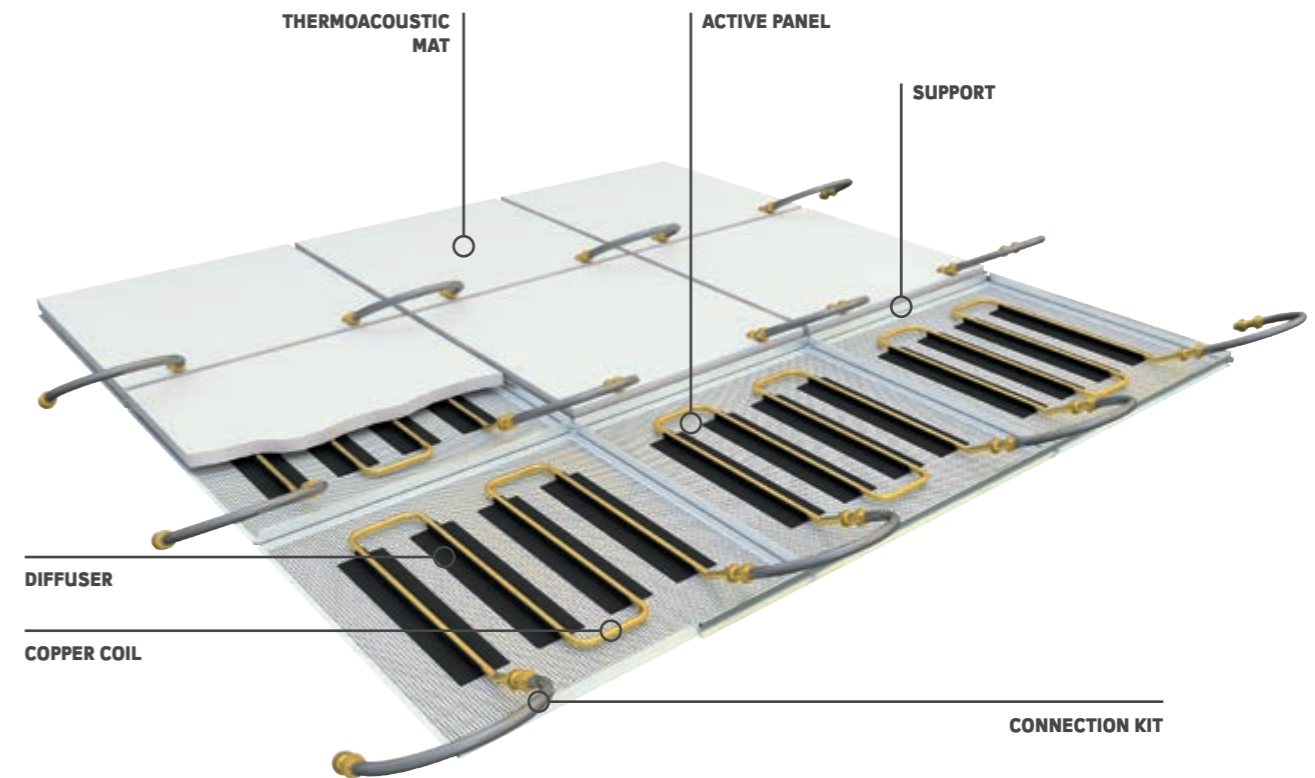

GK60X60 PSV PANELS AND SUPPORTS

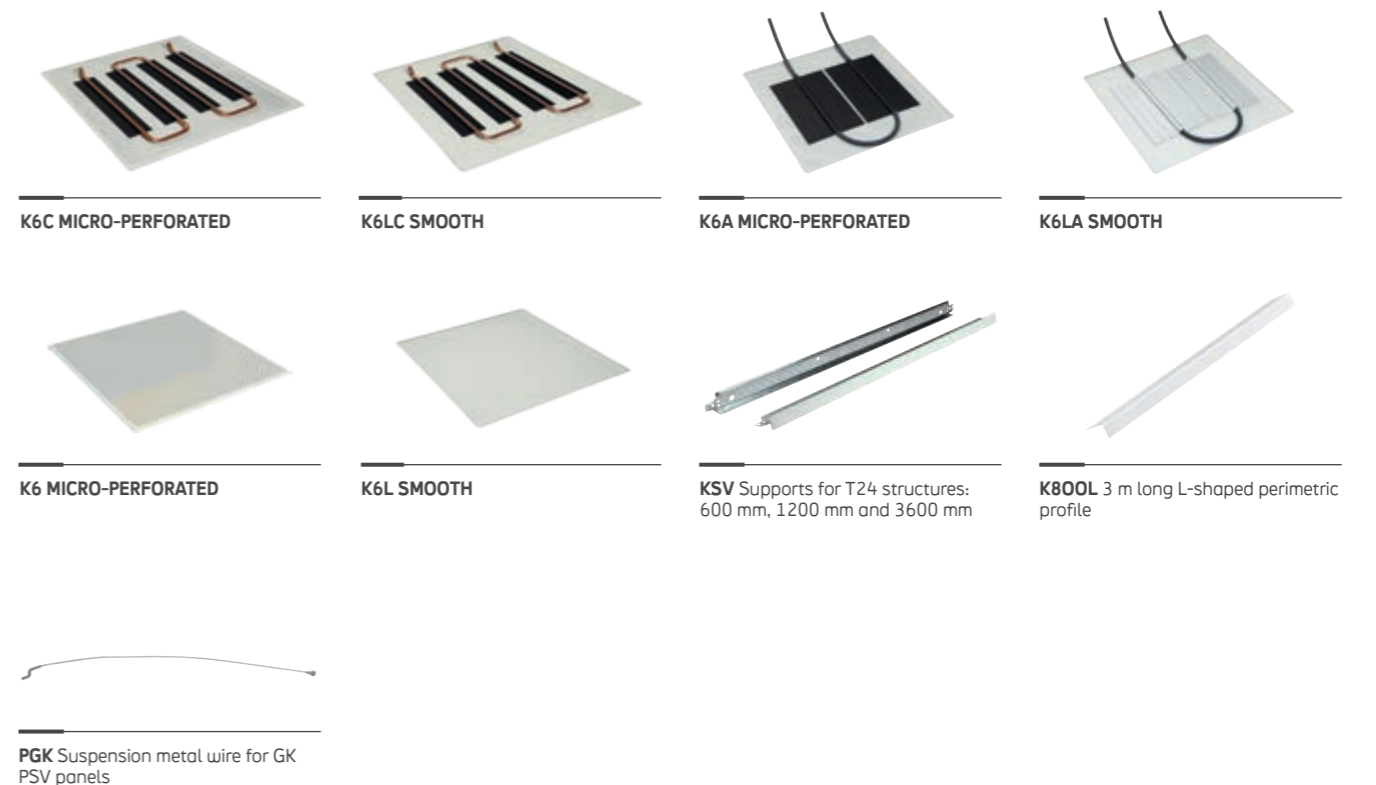

The system is structurally represented below with plan and section views:



SUPPORT AND PANELS

KSV36X 24 mm base supports L=3600 mm

KSV12X 24 mm base supports L=1200 mm

KSV6X 24 mm base supports L=600 mm

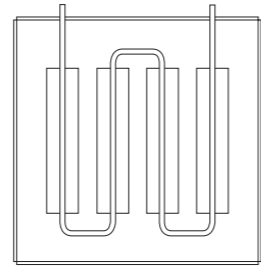

K6C or **K6A** 575x575 mm active panel

PANEL SUSPENSION



Exposed reversed T-shaped support with 24 mm base supports. This standard structure is lightweight, with a wide diffusion range and is generally used with ordinary false ceilings. The main supports are suspended with a typical spring+hanger system, widespread for false ceiling installations.

The side finishes can include passive panels, possibly cut to size, or as an alternative, plasterboard which is used more frequently and offers greater design freedom.

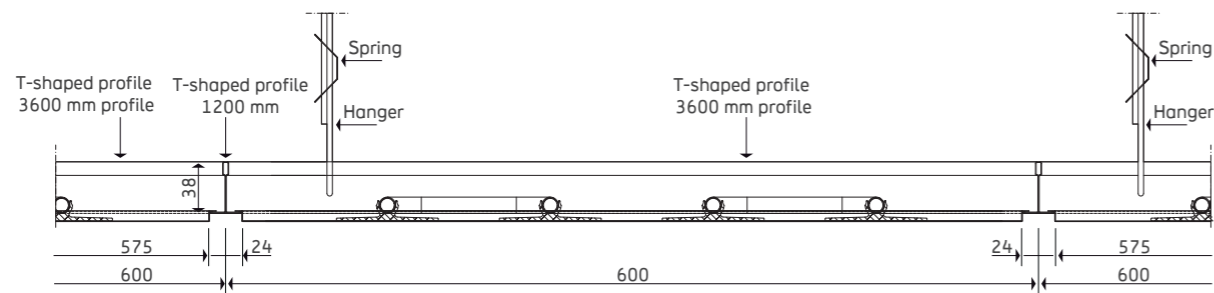

Section view of 24 mm base T-shaped structure for GK60x60 PSV system

APPLICATION EXAMPLES



CORRELATED PRODUCTS



Modular manifold

Manifold accessories

Manifold insulation

Pipe



Connection kits and/or fittings

System additive

Thermoregulation

Air treatment

SYSTEM GK PSV INSTALLATION AND INSPECTIONABILITY

INSTALLATION

The GK PSV system assembly requires the same installation steps provided for traditional false ceilings with a T24 support structure.

First of all, according to the project layout, set the hanging system, then assemble the structure. The installation is completed with panels, according to the steps below:



1. The PGK metal wires are fitted into the corresponding support holes

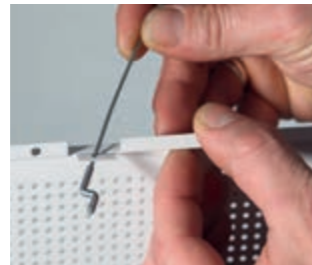

2. The panels are fitted to the wires by hanging them in vertical position



3. The water system connections come next: the panels part of the same circuit are connected one to the other, while the first and last panel of the series are connected to their distribution manifold, one for delivery, the other for return.



4. Connection detail for two adjoining panels

INSPECTIONABILITY

GK PSV panels – image below – are designed for fitting of two metal suspension wires [A] into the flanged tabs [B] to be folded at the work site. The wires are fitted to the T24 support structure [C] during installation.

GK PSV panels can therefore be fitted and positioned vertically, hanging by the two wires, to access the false ceiling and plenum for inspection or maintenance of other installations, even when the system is turned on.

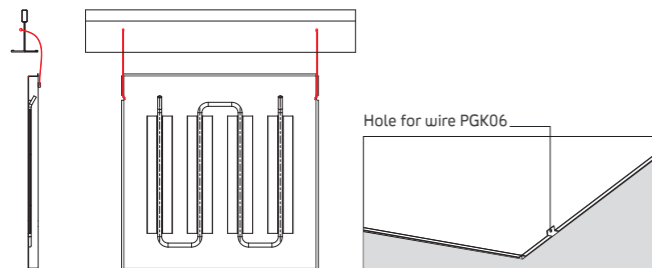

fig. 2.9
Inspectionability of GK PSV radiant ceiling – active and passive panels suspend by wires



ACTIVE METAL PANEL HYDRAULIC CONNECTION

The metal panels of the radiant ceiling circuit can be fitted one to the other. The circuit generally derives from distribution manifolds.

According to the active panel thermal activation system, there are many hydraulic connection options.

A220 activation panels

Connection between the distribution manifolds and panels is made with an anti-oxygen barrier polybutylene pipe - R986S 16x1,5 mm. The connection includes straight and square-shaped RC push-fittings.

Before fitting the polybutylene pipe into the fittings, the RC900 reinforcement bush must be inserted in the pipe itself.



fig. 2.10
Hydraulic connection components for A220 activation panels

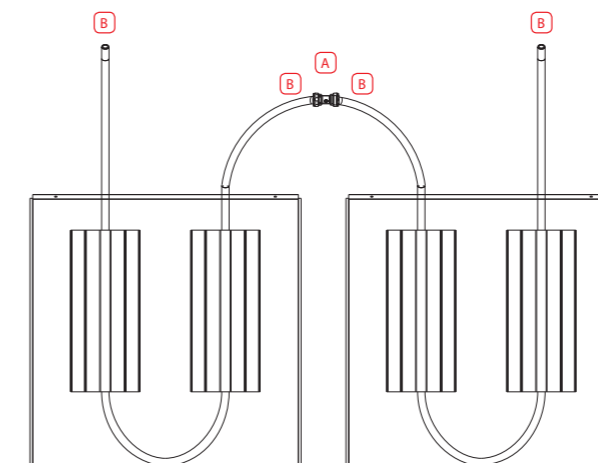

(A) RC-16 straight connection
(B) RC-16 reinforcement bush fitted before inserting the pipe

fig. 2.11
Series connection of A220 activation panels

Panels with C75 activation

C75 thermal activation offers two hydraulic connection options.

The first consists in using the R986S 16x1.5 mm anti-oxygen barrier polybutylene pipe to make the delivery and return connection between the distribution manifolds and panels.

Panels with an integrated 12x1 mm copper coil R986S 12x1,5 mm can be connected with a R986S 12x1.5 mm polybutylene anti-oxygen barrier pipe.

The system uses straight or square-shaped RC push-fittings.

Before fitting the polybutylene pipe into the fittings, the RC900 reinforcement bush must be inserted in the pipe itself.

This connection technique is highly flexible as it enables to easily adapt to any work site issue.

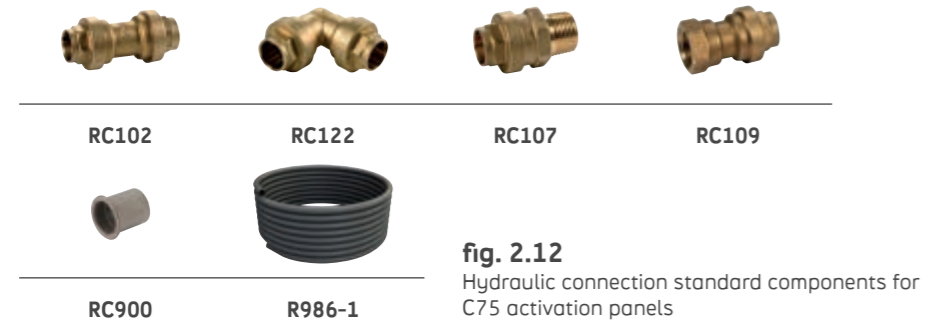

fig. 2.12
Hydraulic connection standard components for C75 activation panels

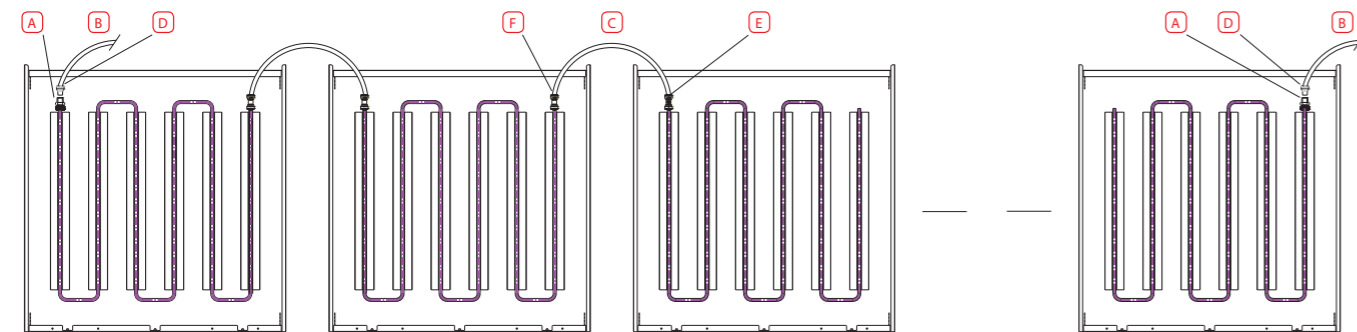

fig. 2.13 Connection in series of C75 activation panels

The use of K85RS and K85RC preassembled connection kits represents a valid, quicker and easier option.

The active panels can be connected in series using a kit including a 900 mm long EPDM flexible pipe with anti-oxygen barrier and a stainless steel mesh sleeve, in addition to two 12 mm RS push-fittings, one at each end of the flexible piping.

The distribution manifold and the panels can be connected using the preassembled kit including a 400 mm EPDM flexible piping with anti-oxygen barrier and a stainless steel mesh sleeve, in addition to a RS push-fitting 12 mm on one size to be fitted into the panel and a 1/2" F threaded fitting on the other.

The delivery/return section between the manifold and the circuit is connected by an RC107 1/2" M fitting and an R986S 16x1.5 mm polybutylene pipe with anti-oxygen barrier to minimize pressure losses.



fig. 2.14
K85RS kit for hydraulic connection of C75 activation panels

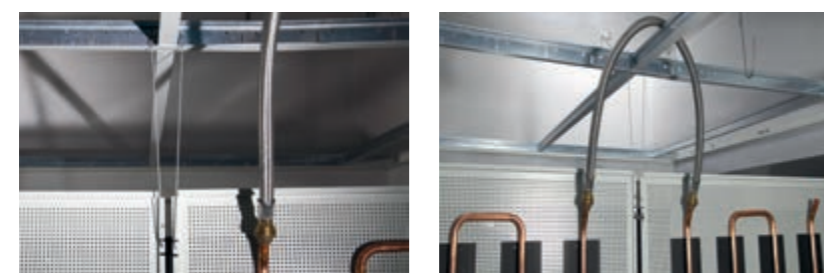

fig. 2.15
Connection in series of C75 activation panels with preassembled kits

TERMOACOUSTIC INSULATION

The use of K820 thermoacoustic panels, both for micro-perforated and the smooth panels, allows to thermally insulate the plenum and absorb the noise from above.

The thermoacoustic panel is made with 100% polyester fibre, irreversibly thermo-bound and dry carded on a black textile support which is also made with 100% polyester fibre with no addition of chemical glues.

The thermoacoustic panel is easy to install: it must be laid with the black textile facing down. The material used allows to perform various types of maintenance, including machine washing and tumble dry, operations generally required a few years after installation for disinfection or for simply cleaning the panel from dust. Various dimensions are available according to the metal radiant ceiling of installation and the panel can be fitted right away. Density and thickness of the thermoacoustic panel have been optimized to guarantee the best functionality for typical indoor applications.



fig. 2.16
Installation of thermoacoustic insulation on panel



Main characteristics

- > Material: thermobound polyester fibre 100%
- > Density: 20 kg/m³ (mat), 40 kg/m³ (support)
- > Thickness: 25 mm
- > Thermal conductivity: 0.03 W/mK
- > Hygroscopicity: 0.1 % of weight
- > Water resistance: flaking-free and unaltered characteristics
- > Vibration resistance: no particle separation after 1 million cycles at 50 Hz
- > Combustion gas: no acids (AFNOR X 70-100)
- > Odours: none
- > Sound absorption at: 0.64 (250 Hz) 0.78 (500 Hz) 1.06 (1000 Hz) 0.98 (2000 Hz)

The house ceiling becomes an efficient air conditioning system,
the ideal solution also for summer cooling.
So perfectly integrated in the architecture to be invisible.

Chapter 3

Plasterboard radiant ceilings

INTRODUCTION

Residential buildings and hotels are the preferential field of application for plasterboard radiant ceilings, in addition to business-oriented ambients and, more in general, the entire commercial sector where civil finishes are required.

The table below (3.1) shows the solutions offered by plasterboard radiant ceilings:

series	panel dimension [mm x mm]	activation
GKC	1200x2000	C100
	1200x1000	C100
	600x2000	C100
GKCS v.2.0	1200x2000	8x1 coil
	1200x1000	8x1 coil
	600x2000	8x1 coil
	600x1200	8x1 coil

fig. 3.1
Types of plasterboard radiant ceilings

GKC AND GKCS V.2.0 PANELS

Plasterboard panels can be active or inactive. Active panels feature thermal exchange thanks to their integrated activation system, while inactive panels have only an aesthetic function.

Both panels are preassembled by combining a plasterboard sheet to an insulating material.



GKC panel

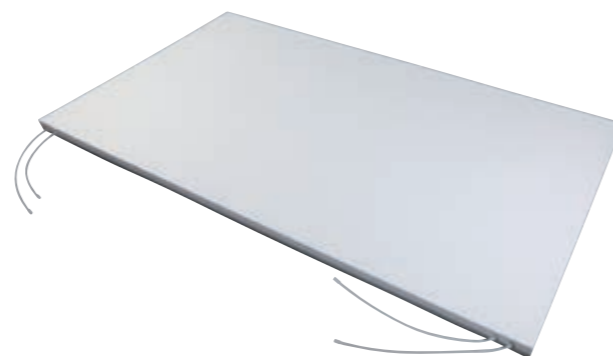

GKCS panel

THE ACTIVATION SYSTEM

Plasterboard radiant panels are available with two different activation systems. Each series – GKC or GKCS v.2.0, with or without an integrated activation system – features the same thickness. The insulation layer offers greater levels of thermal insulation while enabling to rapidly install the false ceiling: in fact, as all panels have the same thickness, the false ceiling coplanar areas require the installation of a structure with the same hanging height, i.e. the structure of that same area is coplanar and uninterrupted.

GKC ACTIVATION

The thermal exchange system of C100 activation panels is represented by a 16x1 mm copper coil combined to aluminium diffusers. The 4 cm-thick insulation layer is made with EPS 150 with graphite.

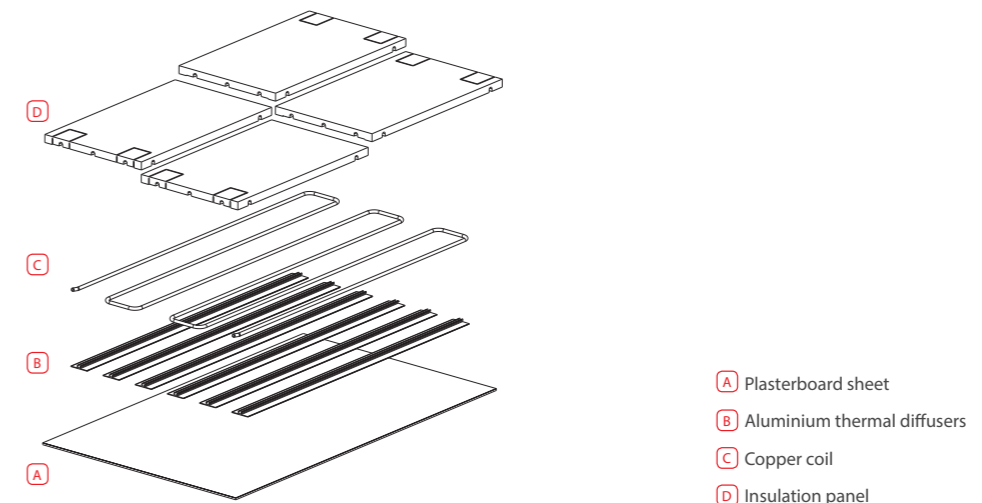

GKCS V.2.0 ACTIVATION

The thermal exchange system of GKCS v.2.0 panels is represented by one (or two for larger panels) PEX 8x1 mm coil integrated in the panel. The 3 cm-thick insulation layer is made of EPS.

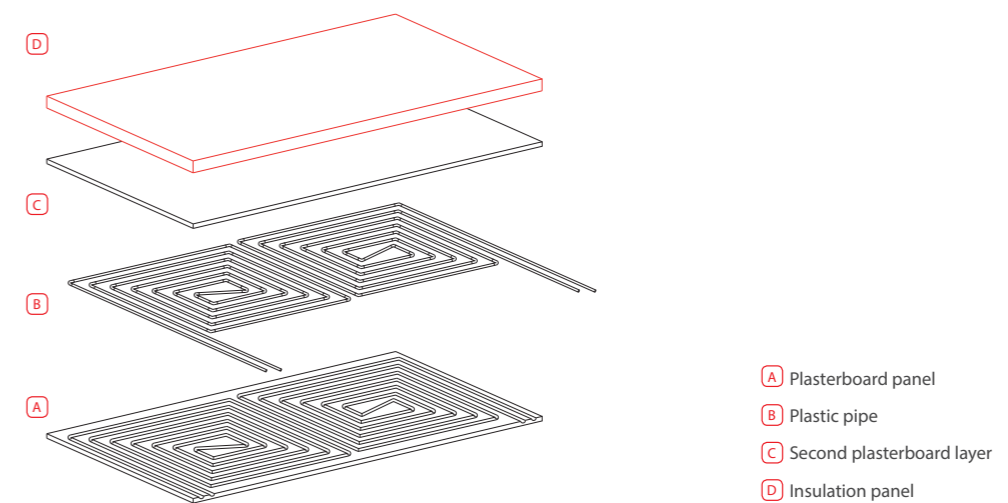

GKC SYSTEM

PLASTERBOARD RADIANT PANEL

WHY GKC

- indicated for residential and similar applications
- possibility to easily integrate elements in the false ceiling
- distribution manifolds installed in inspectionable trapdoors
- manifold-free walls
- reduced pressure loss system

more details on
giacomini.com

INTRODUCTION

GKC is a radiant ceiling made by preassembled panels, featuring a plasterboard finish and using high quality and thermal performing materials.

Designed with heating and cooling of residential buildings in mind, its filed of application naturally extends to hotel rooms, commercial ambients and, more in general, civil buildings requiring a civil-type finish false ceiling.

GKC panels are made by 10 mm-thick plasterboard sheets, an aluminium layer and an EPS150 insulation layer with 40 mm-thick graphite.

The activation system includes a 16x1 mm copper coil embedded in the panel; the system design allowed to combine the thermo-technical requirements with lighting and architectural needs: the pipe inter-distance enables to easily install the lighting elements fitting them directly into the active panels.

PANEL TYPES



KC120
> Modularity: 1200x2000 mm
> Thickness: 50 mm
> Active

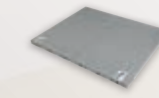

KC120
> Modularity: 1200x1000 mm
> Thickness: 50 mm
> Active



KC120
> Modularity: 1200x1000 mm
> Thickness: 50 mm
> Inactive



KC60
> Modularity: 600x2000 mm
> Thickness: 50 mm
> Active



GKC SYSTEM PLASTERBOARD RADIANT PANEL



- > False ceiling available with three different module sizes
 - 600x2000 mm
 - 1200x2000 mm
 - 1200x1000 mm
- > 10 mm smooth plasterboard panel, with 0.1 mm aluminium steam-barrier and 40 mm EPS 150 insulation panel with graphite
- > C100 integrated thermal activation made with anodized aluminium thermal diffusers combined to a 16x1 mm copper coil pipe
- > Connection in series of panels part of the same circuit
- > Installable with ordinary plasterboard false ceilings
- > Its modularity makes it suitable for every type of ambient
- > Outstanding integration flexibility as spotlights and other false ceiling elements can be embedded in the active panels
- > Inspectionable system: by installing false ceiling trapdoors near the distribution manifolds, the false ceiling conceals the entire system, without encumbering the ambient walls
- > Inactive panels made by a plasterboard sheet and a 40 mm EPS 150 insulation layer with graphite are used for side compensation. This improves the ambient insulation upwards; in addition, all panels feature the same thickness, greatly reducing the installation times

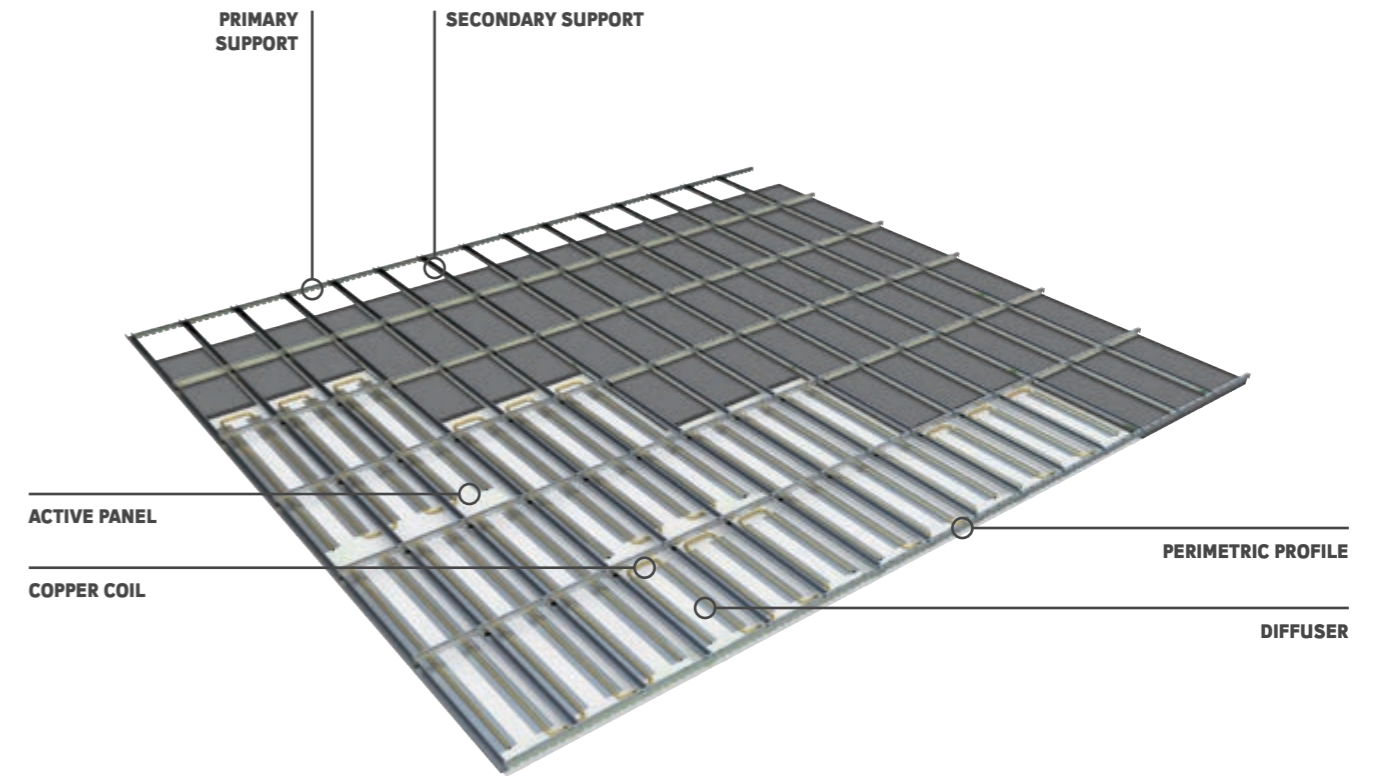

STRUCTURE PANELS AND COMPONENTS



The system structure is shown in the plan and section view pictures below:

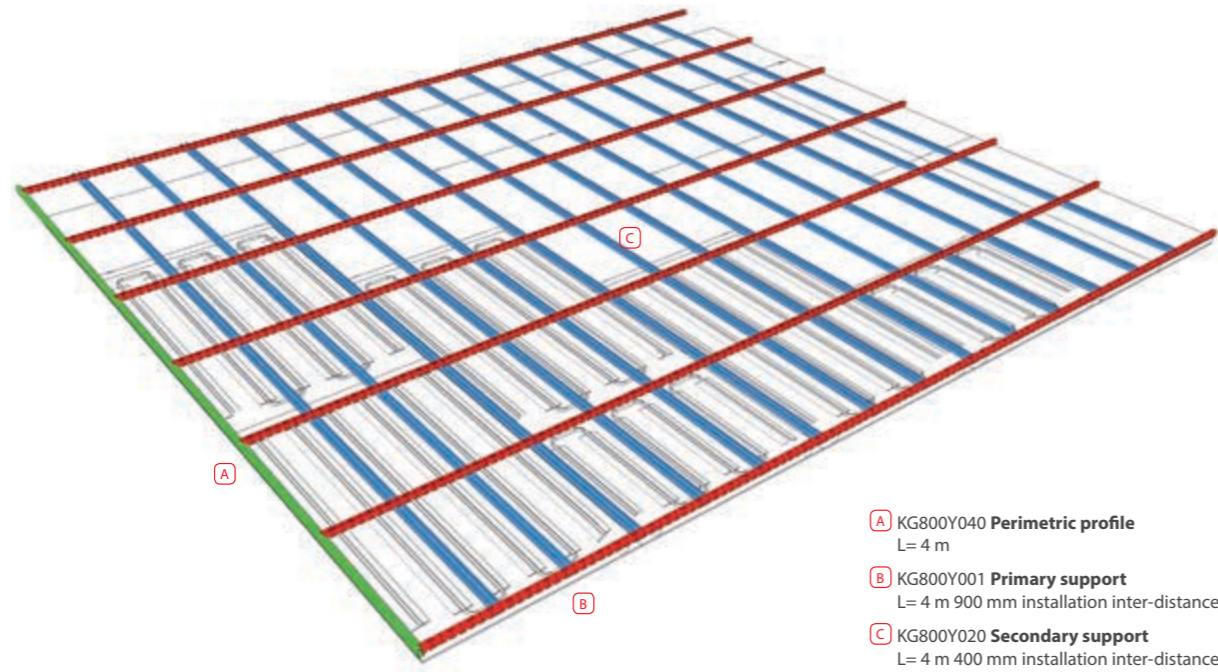

The support structure includes primary supports connected to the slab through Ø 4mm suspension hangers and secondary supports fitted on the primary supports:

- 40x28 mm U-shaped primary supports, length 4 m, thickness 0,6 mm
- 50x27 mm C-shaped secondary supports, length 4 m, thickness 0,6 mm

The perimetric areas are covered with KC120 insulated plasterboard inactive panels.

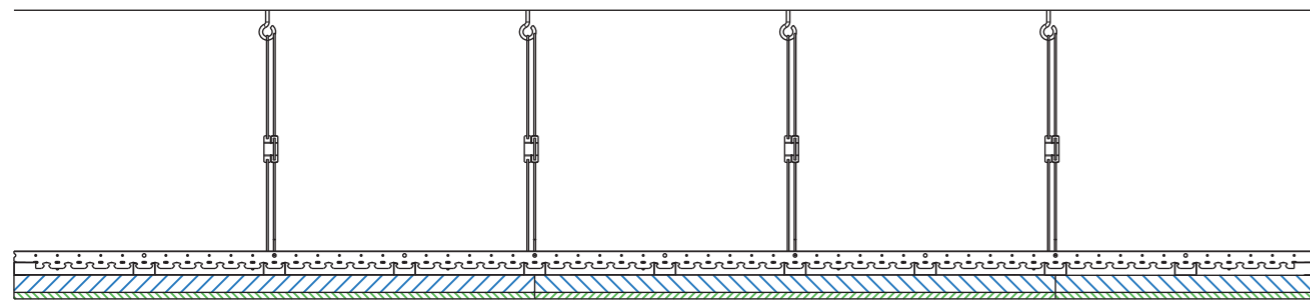

GKC system structure section view

APPLICATION EXAMPLES



CORRELATED PRODUCTS

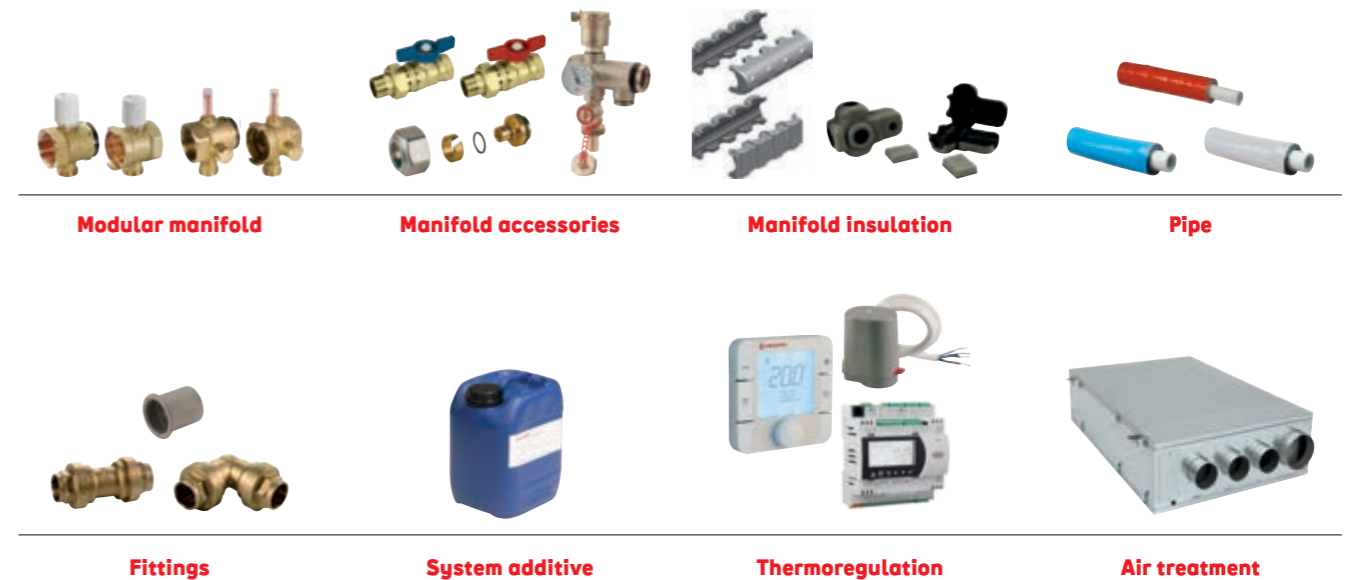

GKCS V.2.0 SYSTEM

PLASTERBOARD RADIANT PANELS

WHY GKCS V.2.0

- indicated for residential or similar applications
 - possibility to embed devices in the false ceiling
 - walls not encumbered by the distribution manifolds
 - inspection trapdoors for direct access to the distribution manifolds
- more details on giacomini.com

INTRODUCTION

The **GKCS v.2.0** radiant ceiling is made by preassembled plasterboard panels.

Designed for heating and cooling of residential buildings but also suitable for applications in hotel rooms, commercial areas and, more in general, in buildings requiring a civil-finish false ceilings.

GKCS v.2.0 panels are made of a 15 mm-thick plasterboard sheet and an EPS 30 mm-thick insulation layer.

The activation system is situated between these two layers and includes one (or two, according to the panel dimensions) 8x1 mm PEX coil.

PANEL TYPES



KS120
> Modularity: 1200x2000 mm
> Thickness: 45 mm
> Active



KS120
> Modularity: 1200x2000 mm
> Thickness: 45 mm
> Inactive



KS60
> Modularity: 600x1200 mm
> Thickness: 45 mm
> Active



KS60
> Modularity: 600x2000 mm
> Thickness: 45 mm
> Active



GKCS V.2.0 SYSTEM PLASTERBOARD RADIANT PANELS



- > Four different modules for false ceiling panels:
 - 600x2000 mm • 1200x2000 mm
 - 600x1200 mm • 1200x1000 mm
- > 15 mm smooth plasterboard panel, with EPS 30 mm insulation panel. Overall dimension 45 mm
- > Thermal activation integrated in the panel with 8x1 mm PEX coils. The 1200x1200 mm panel integrates two coils positioned so as to obtain two 1200x1000 mm panels with a transversal cut
- > Parallel connection of panels part of the same circuit
- > Installable with ordinary plasterboard false ceilings
- > Recommended for wall installation
- > Its modularity makes it suitable for every type of ambient
- > Possibility to embed spotlights and other false ceiling devices in the compensation panels
- > Inspectionable system: by installing false ceiling trapdoors near the distribution manifolds, the false ceiling conceals the entire system, without encumbering the ambient walls.
- > Inactive panels made by a plasterboard sheet and a 30 mm EPS insulation layer are used for side compensation. This improves the ambient insulation upwards; in addition, all panels feature the same thickness, greatly reducing the installation times

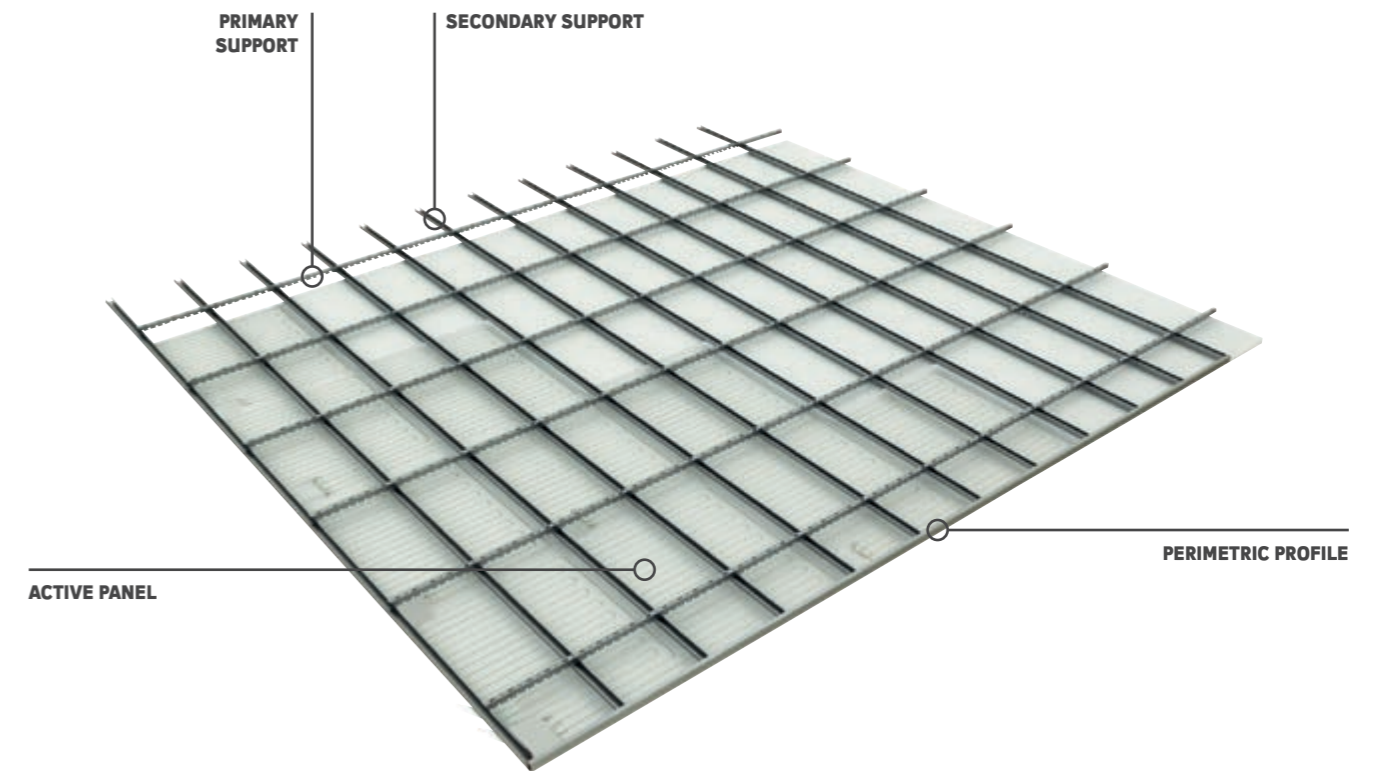

STRUCTURE PANELS AND COMPONENTS

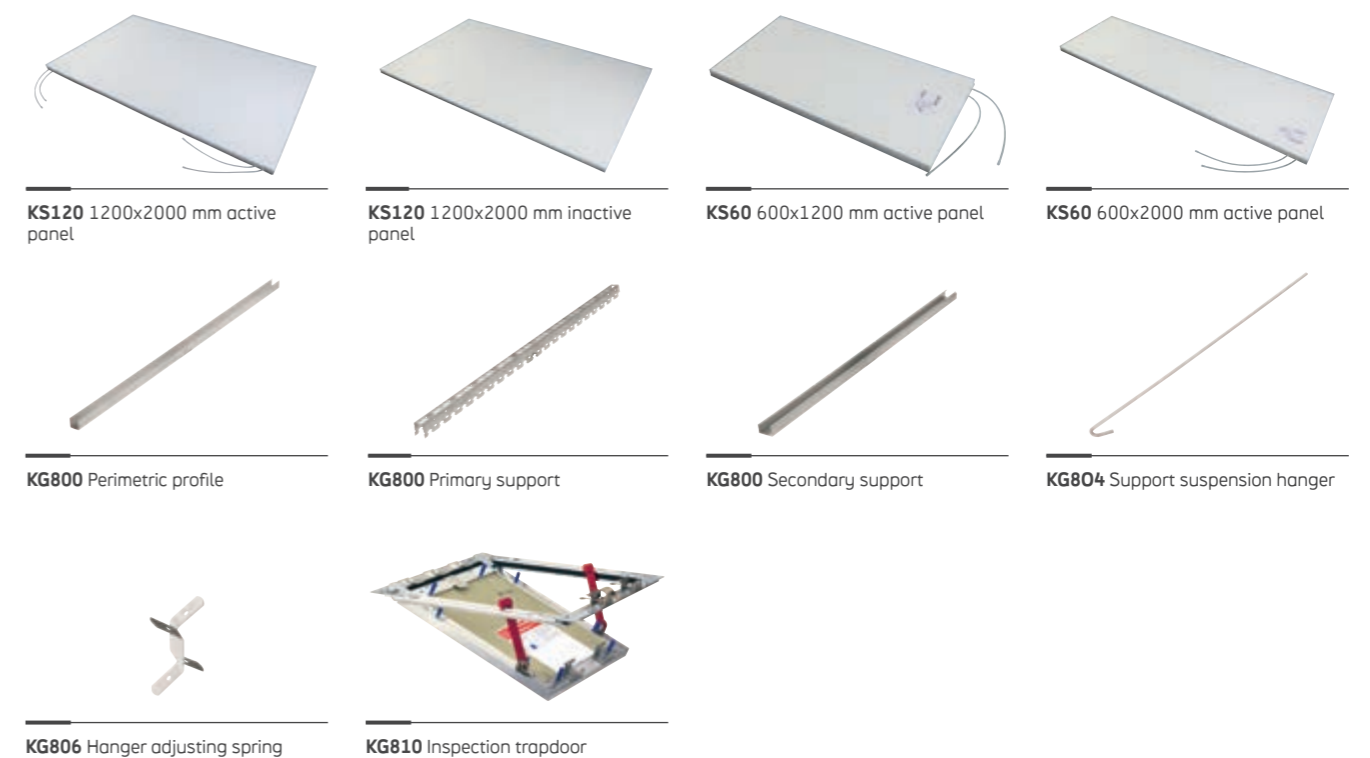

The system structure is shown in the plan and section view pictures below:

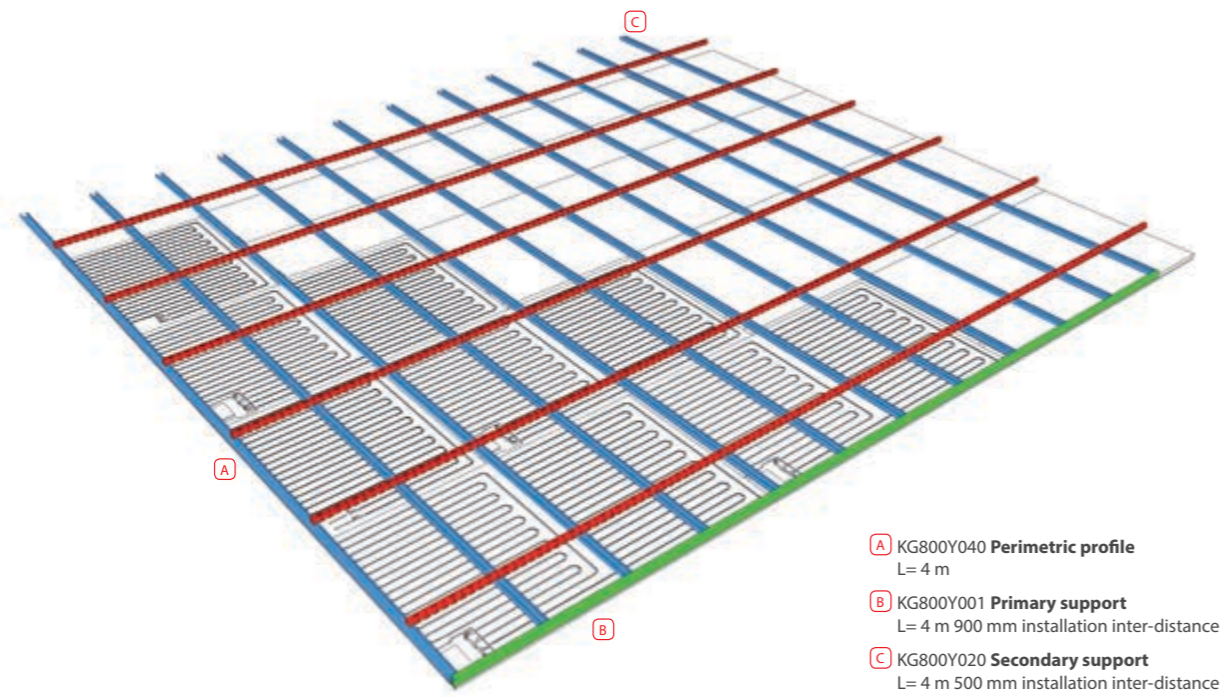

The support structure includes primary supports connected to the slab through Ø 4mm suspension hangers and secondary supports fitted on the primary supports:

- 40x28 mm U-shaped primary supports, length 4 m, thickness 0,6 mm
- 50x27 mm C-shaped secondary supports, length 4m, thickness 0,6 mm

The perimetric areas are covered with KS120 insulated plasterboard inactive panels.

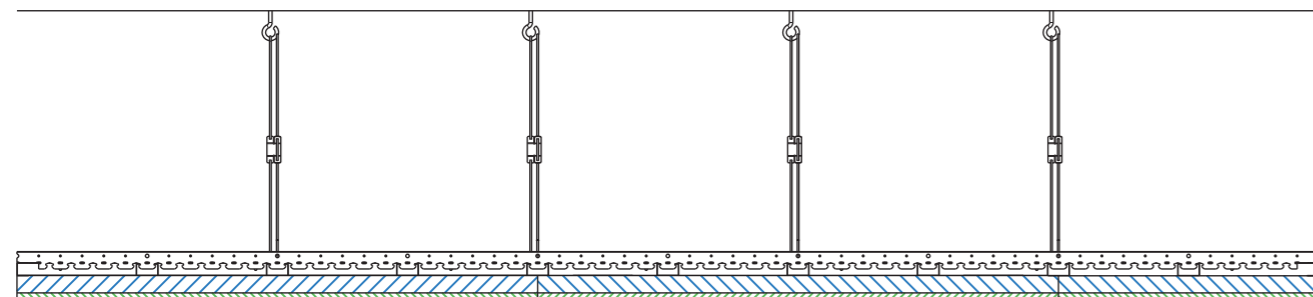

GKCS system structure section

APPLICATION EXAMPLES



CORRELATED PRODUCTS

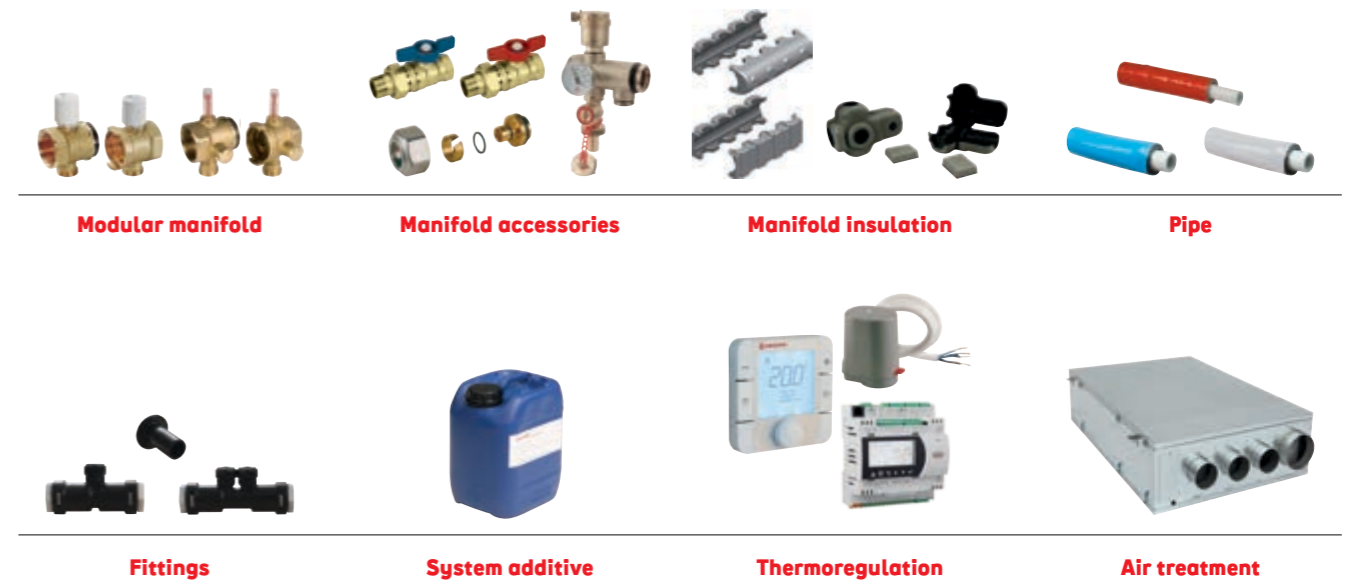

PLASTERBOARD ACTIVE PANEL HYDRAULIC CONNECTION

Hydraulic connection of GKC active panels

The GKC radiant ceiling provides for connection in series of the panels part of the same circuit, which generally derives from distribution manifolds.

Connection between the distribution manifolds and panels is obtained through an R986I - 16x1,5 mm pre-insulated polyethylene pipe with anti-oxygen barrier. The system uses RC straight and L-shaped push-fittings.

Before inserting the polybutylene pipe into the fittings, the RC900 reinforcement bush must be installed inside the pipe itself. The active panel insulation provides an opening to install RC straight or L-shaped fitting for connection. Parts that are not pre-insulated require adequate thermal insulation.



fig. 3.2
GKC panel hydraulic connection components

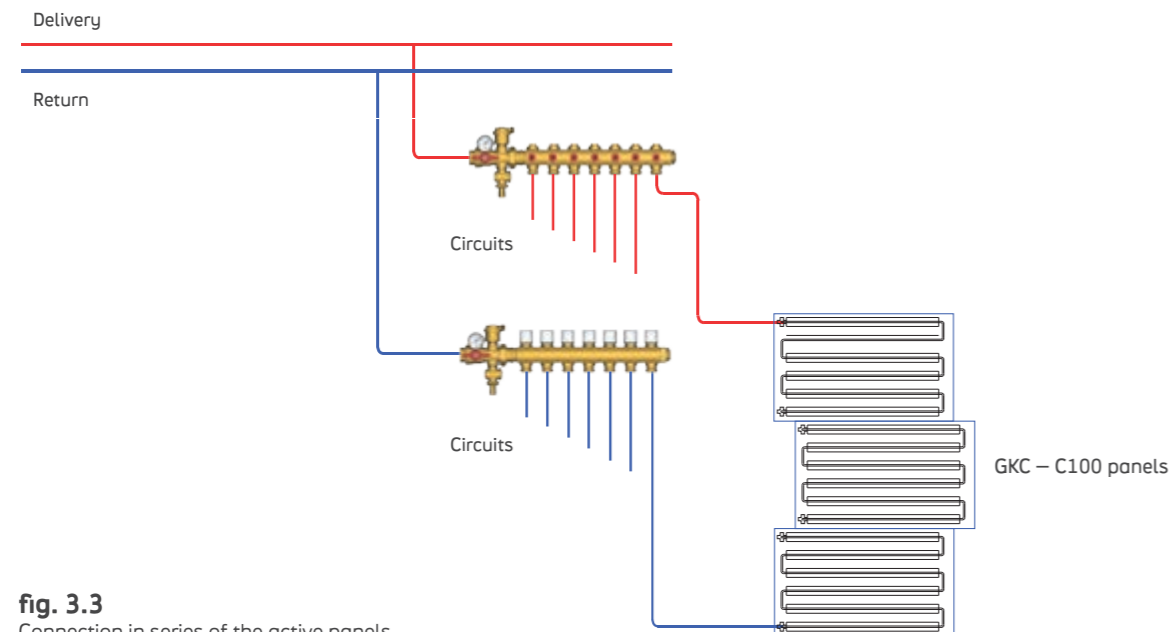

fig. 3.3
Connection in series of the active panels

GKCS v.2.0 active panel hydraulic connection

The GKCS v.2.0 radiant ceiling provides for connection in series of the panels of the same circuit, which generally derives from distribution manifolds. This circuit approach is based on constructive reasons: active panels under nominal conditions feature the same loss of pressure, about 2 m.c.a., so exploiting this factor is helpful to try to obtain self-balanced circuits.

Panel connections use 20x2 mm multilayer pipes available as non-insulated bars or pre-insulated rolls: non-insulated parts must be insulated with adequate thermal insulation. The system uses RC plastic push-fittings.



fig. 3.4
GKCS v.2.0 panel hydraulic connection fittings

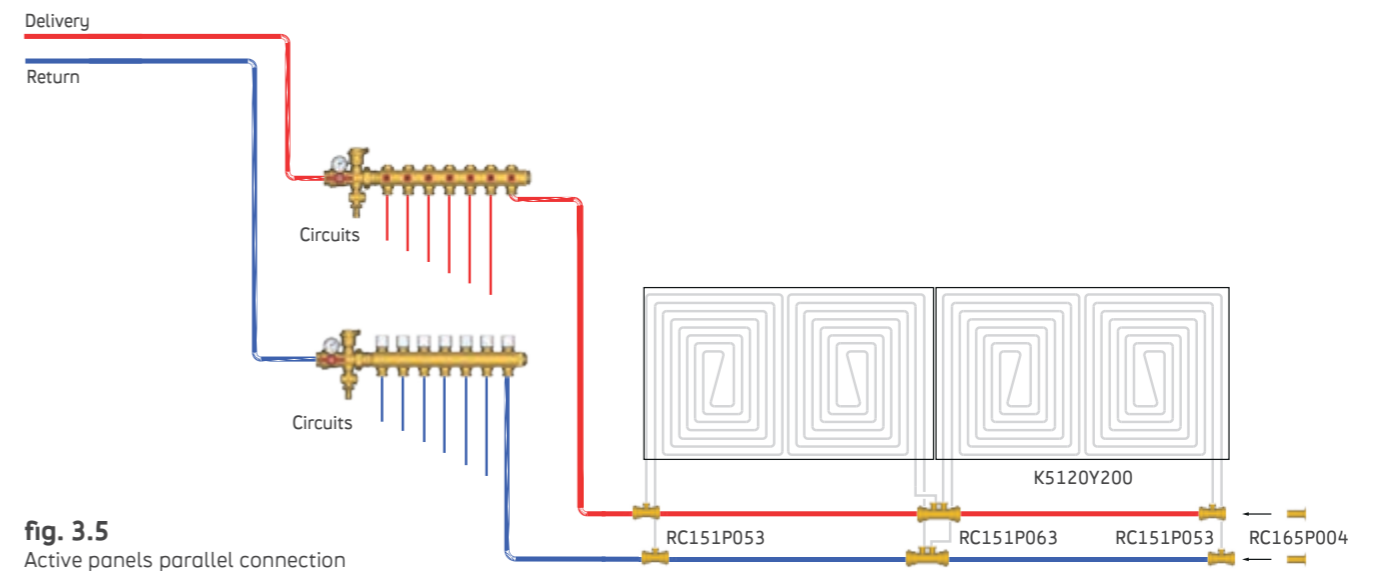

fig. 3.5
Active panels parallel connection

INSPECTIONABILITY OF GKC AND GKCS PLASTERBOARD RADIANT CEILINGS

Availability of spaces is a must. By installing trapdoors near the distribution manifolds, the false ceiling conceals the entire system, without encumbering the ambient walls to be used for other functions.



A safe product with the renown outputs certified according to the regulations in force.
A top quality choice which speaks by its numbers.

Chapter 4

The outputs

THE OUTPUTS

Planning of a radiant ceiling system requires knowledge of the heating and cooling active panel outputs. This is a crystal clear concept but poorly interpreted when it comes to practice.

The thermal and refrigerating power exchanged by a radiant ceiling with the ambient is always established starting from the outputs certified¹ according to Rules EN 14037 (heating) and EN 14240 (cooling).

Outputs expressed according to these two essential Rules may then be adjusted to establish the actual outputs of an installed radiant ceiling.

Great care and experience are required to establish the “planning” outputs of a radiant ceiling.

We will try to offer below a useful tool to be used as safe guidelines for planners who choose radiant ceiling systems.

NOTES

¹ Issued by a credited lab.



fig. 4.1
Giacomini Labs: detail of the thermostatic chamber certified by Rule EN 14240

OUTPUTS ACCORDING TO RULES EN 14037 AND EN 14240

These two in-context standards determine the criteria to experimentally establish the thermal and refrigerating outputs for an active panel activation system; knowledge of this fundamental data enables to establish the outputs of the active panel according to the Rule provisions.

The EN 14037 and EN 14240 test results allow to create output diagrams for the various activation systems with DeltaT between ambient temperature and the average water temperature expressed by the abscissa and the specific power for active surface unit W/m² by the ordinate.

The picture below shows an example of the C75 activation output diagram:

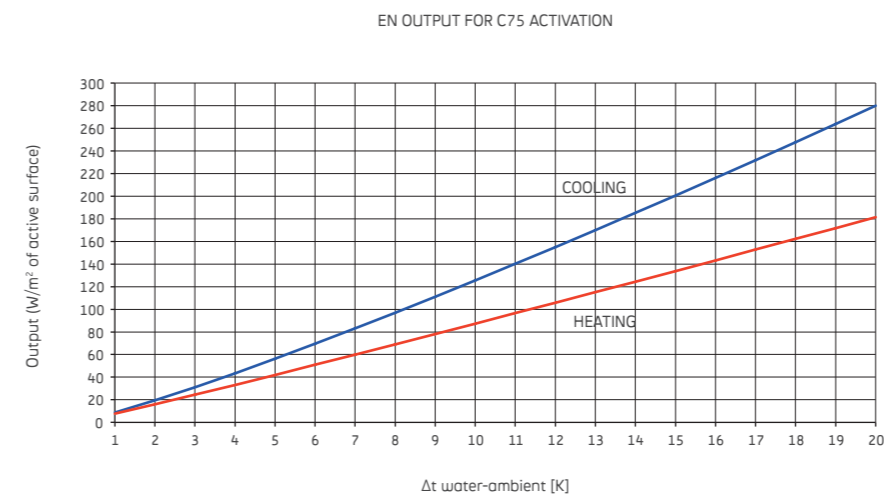

fig. 4.2 EN output for C75 activation

The Rules enable to express the specific outputs with parametric equations easily implementable for calculation:

$$q_H = C_H \cdot \Delta T^{nH} \text{ [W/m}^2\text{]}$$

> output for heating active surface unit

$$q_C = C_C \cdot \Delta T^{nC} \text{ [W/m}^2\text{]}$$

> output for cooling active surface unit

Where $\Delta T = \left| T_o - \frac{(T_m + T_r)}{2} \right|$, as:

T_o = ambient operating temperature

T_m = delivery temperature to the radiant ceiling

T_r = return temperature from the radiant ceiling

Parameters typical of the various activation systems to be used in the equations above are specified by the test certificates.

So far only the specific output for panel active surface units could be established. We will need to rely on a diagram to expand the output concept to the entire panel. By using the GK60- C75 activation radiant ceiling with 150 mm base supports as an example, we highlight the following areas:

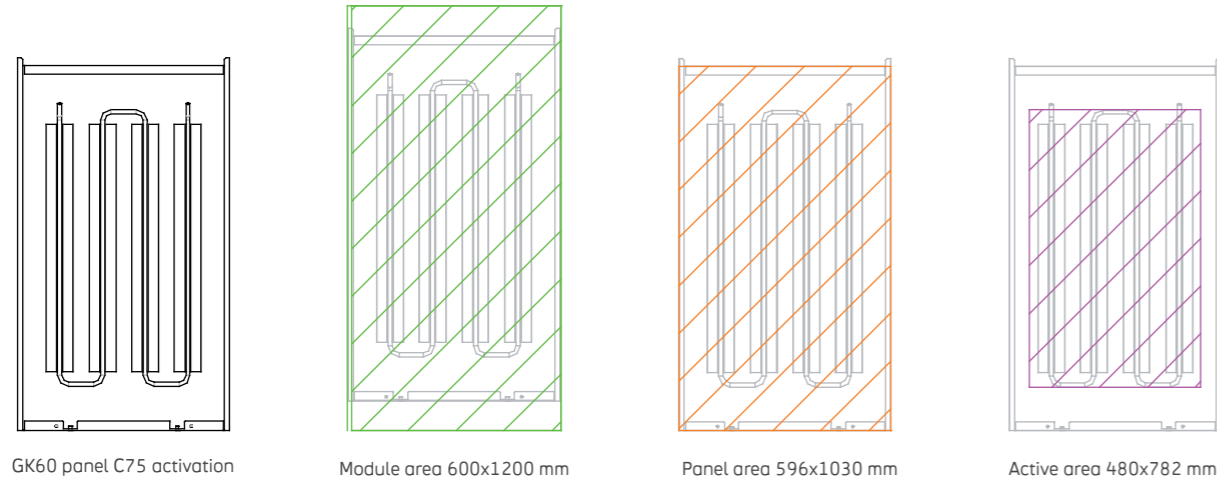

fig. 4.3
The different areas characterizing radiant ceilings

- > Module area: the surface covered by a false ceiling modular unit; in this case it is equal to 600x1200 mm = 0,72 m²
- > Panel area: the surface covered by a panel, equal to 596x1.030 mm = 0,614 m²
- > Active area: defined by Rule EN 14240, it is the panel surface covered by activation; in this example it is equal to S_o = 480x782 mm = 0,375 m²

Given these preliminary remarks, it is easy to establish the integral output of an active panel: just multiply the EN output for the active area S_o:

$$Q_H = q_H \cdot S_o \text{ [W]}$$

$$Q_C = q_C \cdot S_o \text{ [W]}$$

These analytical relations enable to create the EN output diagrams below related to the entire panel and representing the main tool for heat technology planners.

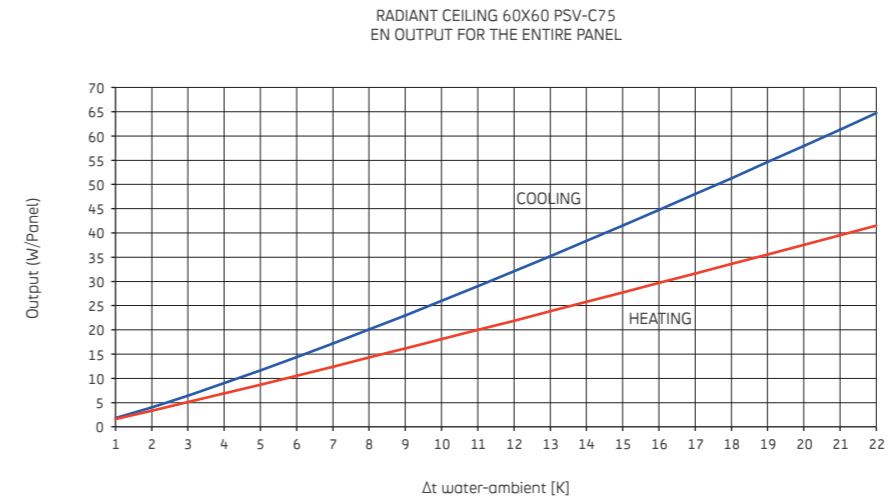

fig. 4.4 EN output for a 60x60 PSV – C75 panel

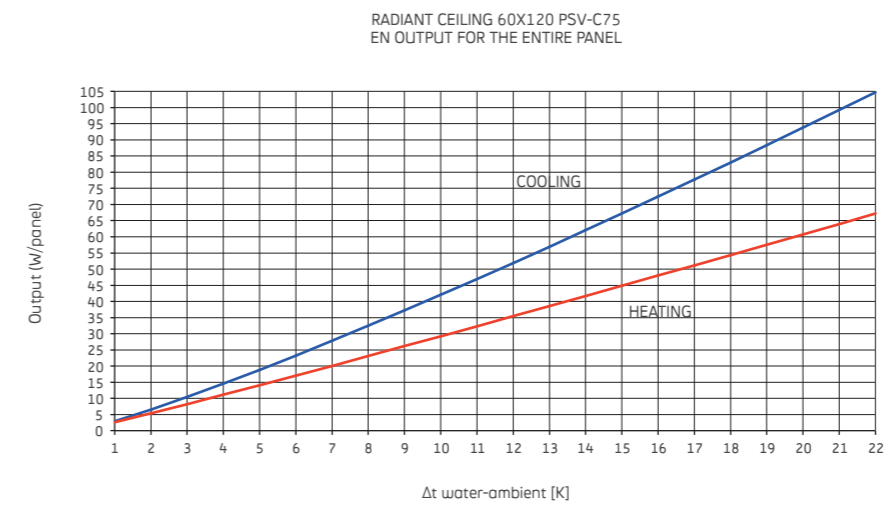

fig. 4.5 EN output for a 60x120 PSV – C75 panel

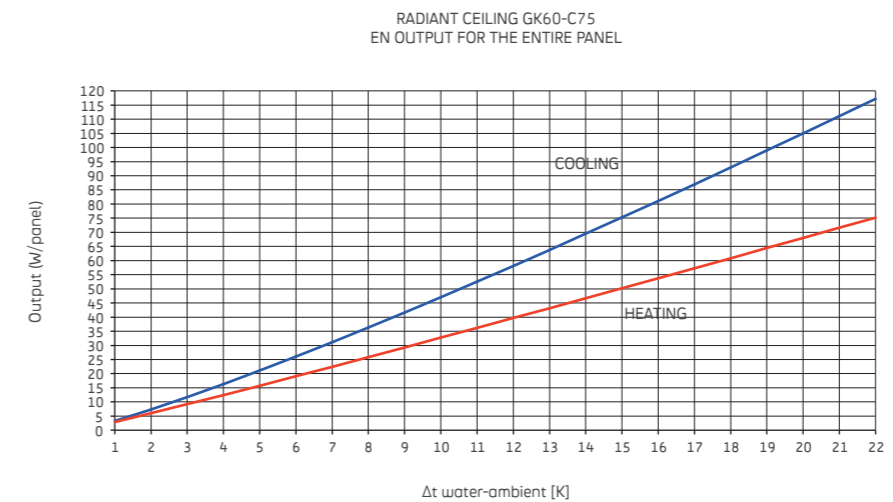

fig. 4.6 EN output for a GK60 – C75 panel

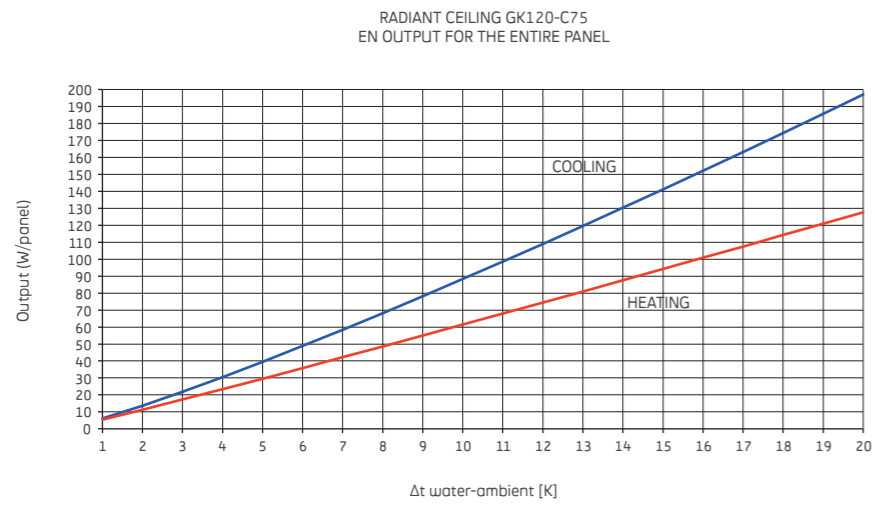

fig. 4.7 EN output for a GK120 – C75 panel

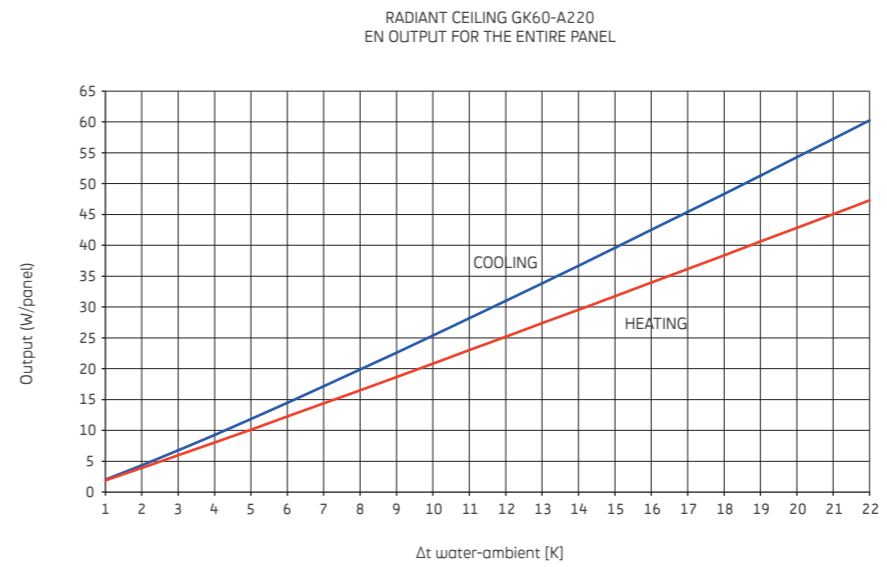

fig. 4.10 EN output GK60 – A220 panel

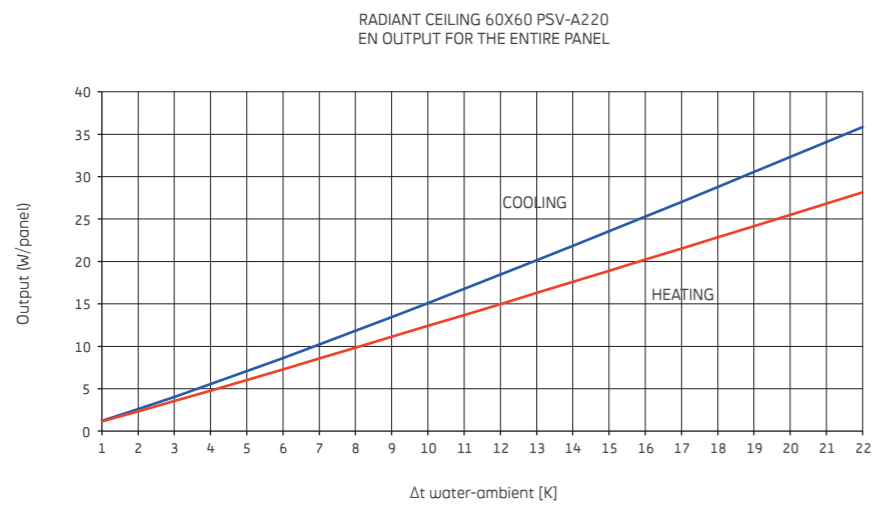

fig. 4.8 EN output for a 60x60 PSV – A220 panel

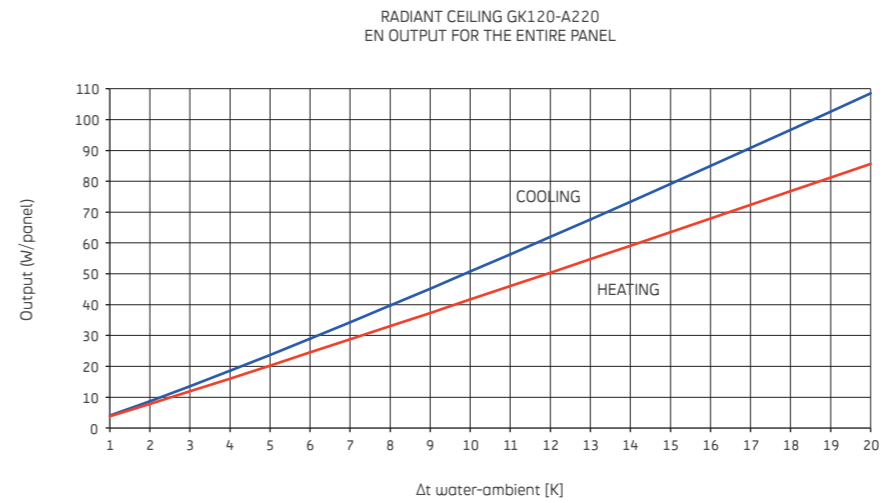

fig. 4.11 EN output for a GK120 – A220 panel

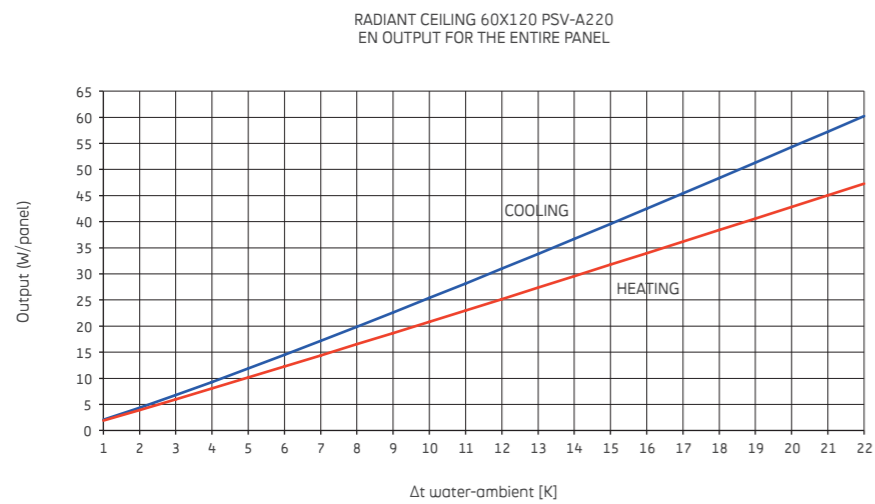

fig. 4.9 EN output of a 60x120 PSV – A220 panel

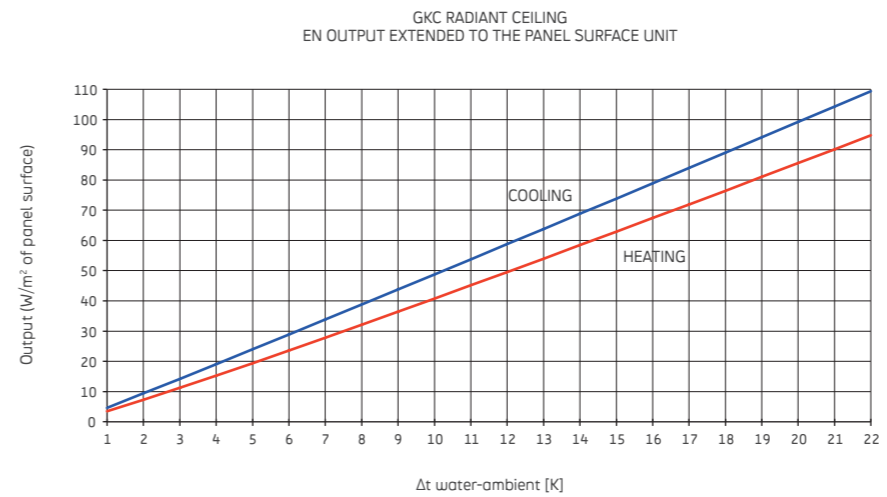

fig. 4.12 EN output for a GKC series panel

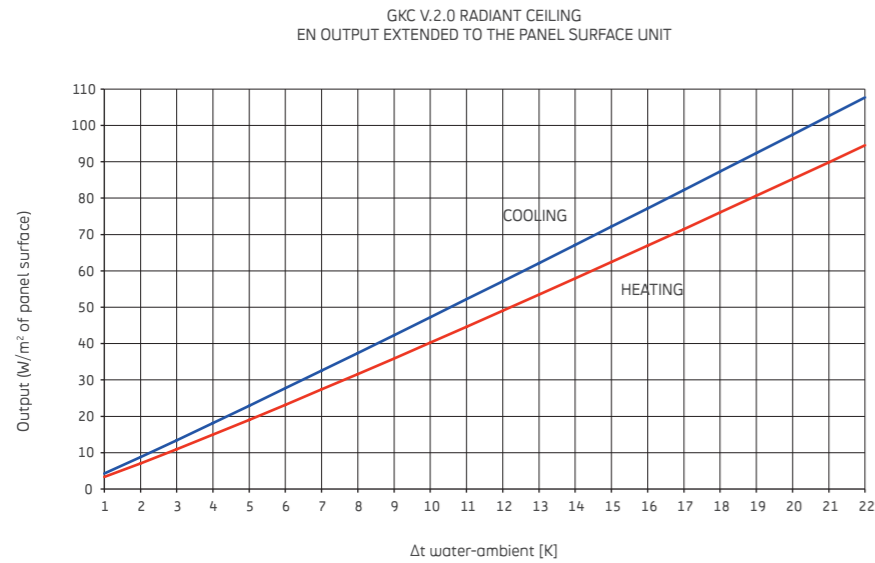

fig. 4.13 EN output for a GKCS v.2.0 panel

OUTPUT CORRECTIVE COEFFICIENTS

The EN thermostatic chamber outputs are generally not those used directly for planning calculations: other additional factors should be taken into consideration: a correct assessment requires in-depth knowledge of the dynamics connected to the installed radiant ceilings.

Height factor - F_o

Thermostatic chamber tests are generally performed with a 2,70 m height; the Height factor F_o is used to take into account the actual installation height and it is defined as:

$$F_o = 1,12 - 0,045 \cdot H$$

where H represents the radiant ceiling installation height from the floor. This formula is valid for H values up to 5 m.

Ventilation factor - F_v

Thermostatic chamber tests are performed with no mechanical ventilation. But this is not a real-life condition and a corrective coefficient F_v should be adopted to take into account an output increase caused by the ambient air movement. Proper evaluation of the F_v coefficient requires great experience; based on numerous and accurate tests in addition to many practical installation examples, we recommend maintaining the F_v coefficient between 1,05 and 1,15, keeping in mind that the distribution system of air, its temperature and the type of radiant false ceiling affect this value. With no ventilation, this value is obviously $F_v=1$.

Façade factor - F_f

Thermostatic chamber tests should be carried out verifying the wall temperature; in practice, however, walls represent a key for false ceiling energy exchange. Ambients with large windows, especially those with a low solar factor, may experience thermal

exchanges definitely greater than those expected according to the thermostatic chamber tests.

This aspect has been widely evaluated in numerous practical tests by Giacomini as well; with no need to dwell on complex calculations, we simply recommend the introduction of a F_f value of about 1,1, keeping in mind that this can vary in practice between 1,05 and 1,2.

So, the general equation for the integral output of an active panel is:

$$Q = q \cdot S_o \cdot F_o \cdot F_v \cdot F_f \text{ [W]}$$

The use of these coefficients prevents the excessive over dimensioning of radiant ceilings; on the other hand, their improper use may mislead in the wrong direction.

SUMMARY TABLE

With reference to the symbols introduced above, the following planning conditions are taken into consideration:

- > Heating: $T_o = 20 \text{ °C}$
- > Cooling: $T_o = 26 \text{ °C}$

Metal radiant ceilings

- > Heating: $T_m = 38 \text{ °C}$
 $T_r = 35 \text{ °C}$
- > Cooling: $T_m = 15 \text{ °C}$
 $T_r = 17 \text{ °C}$

By considering an installation at about 2,70 m from the floor, we can reasonably, but precautionarily assume a global corrective coefficient of 1,05 in winter and 1,10 in summer. By exploiting the diagrams above, we obtain the table below (fig. 4.14) which summarizes the integral outputs of each panel, useful for a rapid indicative calculation for radiant ceiling systems.

Plasterboard radiant ceilings

- > Heating: $T_m = 40 \text{ °C}$
 $T_r = 37 \text{ °C}$
- > Cooling: $T_m = 14 \text{ °C}$
 $T_r = 16 \text{ °C}$

TYPICAL PLANNING OUTPUTS

panel	activation	output Q_h [W] when heating	output Q_c [W] when cooling
GK60x60 PSV	C75	32	29
GK60x60 PSV	A220	22	17
GK60x120 PSV	C75	52	46
GK60x120 PSV	A220	37	28
GK60	C75	58	52
GK60	A220	37	28
GK120	C75	109	97
GK120	A220	74	56
GKCS v.2.0 - 1200x2000	8x1 coil	197	138
GKCS v.2.0 - 600x2000	8x1 coil	99	69
GKCS v.2.0 - 600x1200	8x1 coil	59	41
GKCS v.2.0 - 1200x1000	8x1 coil	99	69
GKC - 1200x2000	C100	198	142
GKC - 1200x1000	C100	99	71
GKC - 600x2000	C100	99	71

fig. 4.14

Embracing warmth in winter, refreshing coolness in summer for absolute comfort year round. Thanks to constant control of temperature and humidity, our cooling solutions stand for the perfect balance in every environment.

Chapter 5

Cooling and air treatment



COOLING AND AIR TREATMENT

INTRODUCTION

Constant thermal comfort in an ambient largely depends on the capacity of efficiently controlling its temperature and humidity levels, preventing air currents.

This is a simple and intuitive concept of common practice proven by the fact that heating systems are required in winter to increase the ambient temperature – the level of humidity is generally adequate and does not require specific regulations – while in summer both temperature (cooling) and humidity (dehumidification) must be reduced to prevent discomfort, possibly by preventing excessive sudden temperature changes between the outside and the inside¹.

The use of radiant ceilings combined to machines specifically designed for dehumidification represents the most efficient installation solution to enjoy summer thermal comfort, both from an energy-saving and achievable result standpoint.

The basic regulation strategy of this installation approach is the simplest:

- > Radiant ceilings reduce the temperature by disposing of the sensible thermal loads
- > Dehumidification systems reduce humidity by balancing the latent thermal loads

DEHUMIDIFICATION MACHINES

Giacomini offers a range of dehumidification machines able to satisfy every installation need; although all models exploit their integrated compression refrigerating cycle, the final result goes way beyond mere dehumidification.

Available are:

- > Isothermal dehumidifiers for false ceiling or wall built-in installation
- > Dehumidifiers with sensible cooling integration for false ceiling or wall built-in installation
- > Machines for controlled mechanical ventilation, false ceiling installation

Based on the functioning principle described below, the benefits offered by this type of machines are quite clear:

- they work on water at 15-18 °C, the same temperature required by radiant ceilings, and enable refrigerating groups to work with water temperatures higher than the typical 7 °C of hydronic air conditioning systems, offering a major benefit in terms of energy performance (EER – Energy Efficiency Ratio)
- they feature a high Latent power/Air flow ratio: up to 2,5 W for every m³/h, minimizing the quantity of air required to cover latent loads, thus offering quietness, absence of air currents and minimum consumption of electric energy.

ISOTHERMAL DEHUMIDIFIERS - OR WITH SENSIBLE COOLING INTEGRATION

Basic version dehumidifiers only provide for humidity reduction. These machines are known as “isothermal dehumidifiers” and fig. 5.1 shows their principle diagram.

This type of machine intakes and filters humid air (1), generally at 26-27 °C, which is then cooled down by a hydronic coil (2) fed with water at about 15-18 °C.

The cooling cycle brings the humid air the closest to condensation by exploiting the water already available to feed the radiant ceiling, with no extra work required from the refrigerating circuit electric compressor.

The cooled air is then ready to flow through the refrigerating circuit evaporation coil (3): during this phase, humidity is released by condensation.

The air now available has a lower humidity rate compared to the ambient in which it is now ready to be released.

Before being ejected, the air first flows through the condensation coil (5, left side): the air temperature is exploited to condensate the refrigerating fluid and repeat the cycle.

But now the air has been warmed up as it absorbed heat from the condensation fluid, so it is advisable to make it flow through a second post-cooling hydronic coil (5, right side) to bring it back to a temperature not higher than the rate it featured when entering the machine.

The air is then released into the ambient.

By slightly changing the machine diagram we obtain a multi-function dehumidifier, a machine able to work as an isothermal dehumidifier or as one able to integrate sensible cooling by ejecting air cooler than the incoming flow.

The principle diagram is shown by fig. 5.2.

Compared to the isothermal dehumidifier diagram, this model features a double condenser in the refrigerating circuit: next to the one interacting with the air (3) is a second one (4) which dissipates all the condensation heat in water.

When this happens – that is when the machine is working with an integration – the air condenser (3) is blocked and cool dry air can be released in the ambient.

DEHUMIDIFIER RANGE AND TECHNICAL CHARACTERISTICS

Giacomini's dehumidifier machines are for built-in wall or false ceiling installation; the latter solution is specifically suitable when serving multiple ambient with one single machine as side-mount fan guarantees a prevalence able to sustain pressure losses of small distribution networks, typical of residential applications.

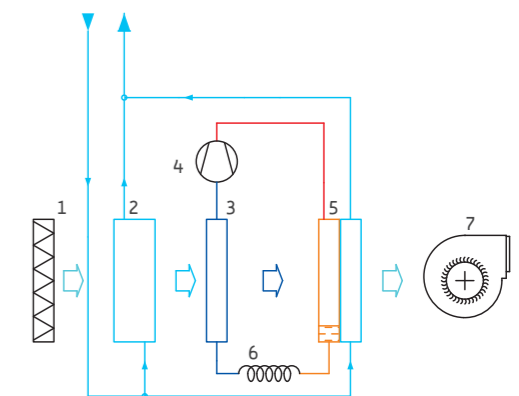

fig. 5.1
Principle diagram of an isothermal dehumidifier

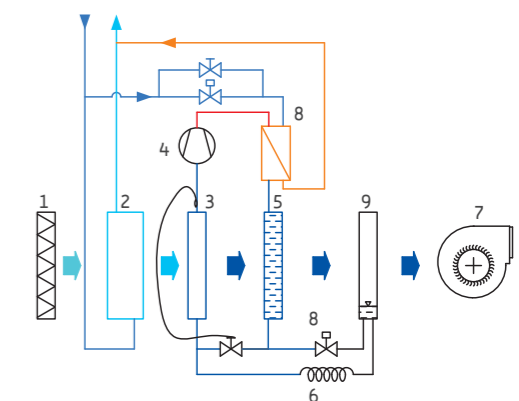

fig. 5.2
Principle diagram of a sensible integration dehumidifier

NOTES

¹ In summer, health authorities generally recommend a difference of 7-8 °C between the outside and inside temperatures.

Below the available versions and corresponding accessories are described. All models include a galvanized sheet monoblock units lined inside with sound-absorbing material: models for wall built-in installation include a metal counter case and a white lacquered wood front panel.

KDP - Built-in installation machines

Isothermal dehumidifier or with sensible power integration (mod. KDPRY024) to be combined with radiant cooling systems

- monoblock unit with galvanized metal sheet structure lined with sound-absorbing material
- removable filtering section
- centrifugal fan with direct coupling 3-speeds motor
- 230V
- availability of steel counter case for wall built-in installation (KDPCY024) and front MDF white-lacquered wood panel (KDPFY024)



KDS - Machines for false ceiling installation

Duct-type dehumidifier, isothermal or with sensible power integration, to be combined with cooling radiant systems

- galvanized sheet structure mono-block unit lined with sound-absorbing material
- removable filtering section
- water-based condenser made with ASI 316 stainless steel brazed-welded plates
- centrifugal fan with direct coupling 3-speeds motor
- availability of 4-ways (KDSY026 and KDSRY026) or 6-ways (KDSRY350) delivery plenums



The table of fig. 5.3 shows KDP and KDS technical data.

	KDPY024	KDPRY024		KDSY026	KDSRY026		KDSRY350	KDSRY500
		dehumidification	integration		dehumidification	integration		
latent power [W] air at 26 °C -65 % feeding water at 15 °C	700	700		740	740		1.110	1.740
sensible power [W] air at 26 °C -65 % feeding water at 15 °C	-	-	900	-	-	950	1.390	2.070
required water flow [l/h]	220	220	290	240	240	320	350	500
water circuit loss of pressure [mm.c.a.]	600	1.200		1.100	1.100	1.100	1.200	1.600
air flow [m³/h]	200	200	300	250	200	300	350	500
max. available prevalence [Pa]	-	-		45	68	60	40	60
absorbed electric power [W] monophasic feeding 230 V - 50 Hz	410	410	430	410	440	460	528	750

fig. 5.3
KDP and KDS technical characteristics

CONTROLLED MECHANIC VENTILATION MACHINES (VMC)

These are complete monoblock machines: in addition to dehumidification, they provide air exchange along with high-efficiency heat recovery. As logically expected, they are suitable for continuous use year round and can be installed in a distribution network of average extension, as long as within the range of residential applications.



They feature a removable filtering section, air heat/ high-efficiency air recovery system, centrifugal fans activated by brushless motors, motorized dampers – for delivery, recirculation, extraction, external air outlet, foul air ejection, refrigerating circuit and hydronic coils. The air released in the ambient is made by two flows: exchange and recirculation air which ratios can be easily set by the user on the control panel within the limits of 80÷160 m³/h for the exchange air flow and 260÷300 m³/h for the released air flow.

As the fans are regulated according to the circulating instant flows, no specific calibration is required based on the topology of the aeraulic network. These machines have the same refrigerating circuit of the one described above for dehumidifiers with sensible integration: two condensers, one for post-heating and one for dissipation. The two VMC machines differ not only for their internal device layout, but also for their dissipative condenser: water-based for KDVRWY300 and air-based for KDVRAY300.

The cooling functioning principle is shown in the diagrams of fig. 5.4, page 96.

The external air flows through the air/air recovery unit (1), where it exchanges sensible heat with the ejection air; once it leaves the recovery unit it mixes with the recirculation air to then undergo a first sensible cooling phase through the water-based coil (3). Then the air mixture undergoes a cooling and dehumidification phase in the evaporator (4), followed by the heating process in the condenser (5). Finally, the air is released in the ambient. The dampers regulate the recirculation and external air flows so as to reach the set points required for the incoming air flow and the exchange air share.

The KDVRAY300 dissipative condenser (6) is cooled down by the extraction air flow and, if necessary, with a supplementary external air flow.

Main functions

- > summer and winter air exchange with high-efficiency heat recovery
- > summer dehumidification with regulation of the air inlet temperature
- > works with water at the temperature required by the radiant ceiling system, 15-18 °C in summer, 35-40 °C in winter
- > foul air extraction
- > ambient air recirculation
- > free-cooling control
- > air inlet temperature and air flows adjustable through the control panel
- > possibility to set activation times
- > when off, closed dampers separate the ambient from the outside

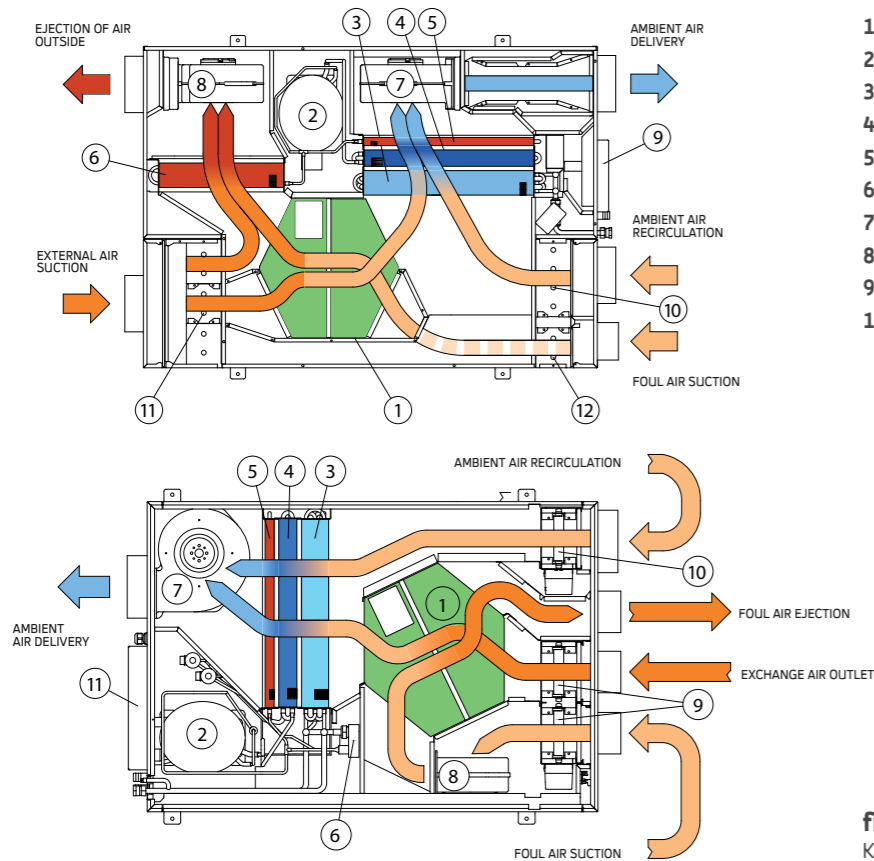

- 1 Air/air recovery unit
- 2 Refrigerating compressor
- 3 Water coil
- 4 Refrigerating evaporator
- 5 Post-heating condenser
- 6 Dissipative condenser
- 7 Delivery fan
- 8 Ejection fan
- 9 Electric panel
- 10-11-12 Dampers

fig. 5.4
KDVRAY300 (above) and KDVRW (below) diagrams

TECHNICAL DATA

	KDVRWY300	KDVRAY300
total latent power [W] – external air at 35 °C -50 %		1.083
useful latent power – referred to recirculation, air at 26 °C -55 %		625
useful sensible refrigerating power [W] – referred to recirculation, air at 26 °C -55 %		1.050
useful thermal power*, feeding water at 45 °C and 60 °C		2.200 - 3.500
required water flow [l/h]	400	300
water circuit loss of pressure [mm.c.a.]	800	1.000
delivery fan flow [m³/h]		80-300
delivery fan useful prevalence [Pa]		120
[m³/h] ejection fan flow	80-160	80-300
ejection fan useful prevalence [Pa]		100
heat recovery unit efficiency – winter: outside -5 °C, inside 20 °C		95 %
heat recovery unit efficiency – summer: outside 35 °C, inside 26 °C		93 %
level of free-field acoustic pressure – distance 1 m [dB(A)]		39
weight [kg]	71	85
absorbed electric power [W] monophasic feeding 230 V – 50 Hz	560	600

* referred to a 300 m³/h recirculation of ambient air at 20 °C

FUNCTIONING DIAGRAMS

EXCHANGE AIR ONLY Exchange air exchanges heat with the extraction air through the recovery unit before flowing through the treatment section and being released in the ambient. The delivery air temperature is adjusted by the water coil.

KDVRAY300

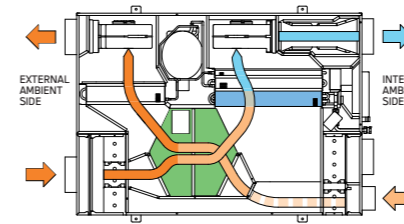

KDVRWY300

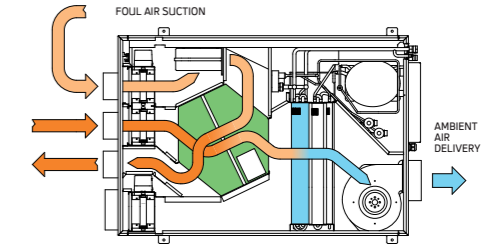

RECIRCULATION ONLY The treatment process involves only the ambient air, which is withdrawn and returned after dehumidification, cooling or heating according to the operational conditions. The KDVRAY300 unit working in summer provides for circulation of an external air flow to cool down the dissipative condenser. The delivery air temperature is adjusted by the water coil.

KDVRAY300

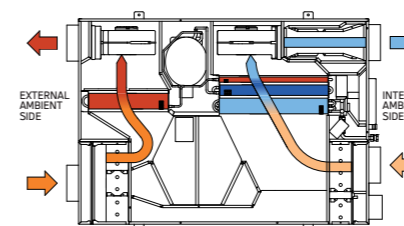

KDVRWY300

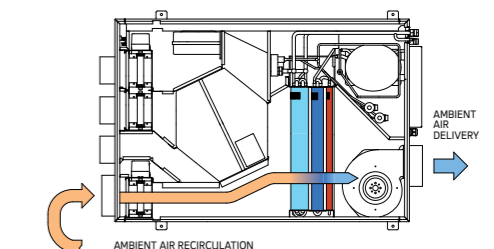

EXCHANGE with RECIRCULATION Exchange air exchanges heat with the extraction air through the recovery unit before mixing with a recirculation air flow, then it is processed by the treatment section and finally released into the ambient. The delivery air temperature is adjusted by the water coil.

KDVRAY300

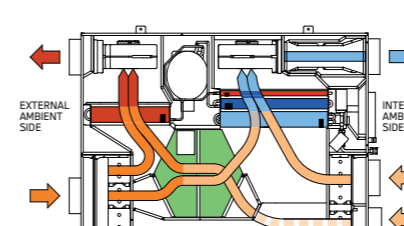

KDVRWY300

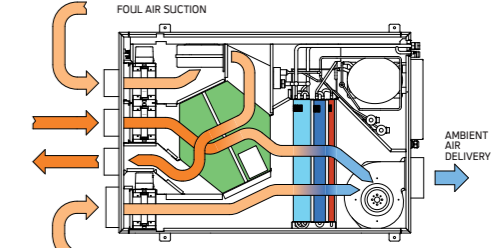

FREE COOLING Enables to exploit free feeds of external air when its temperature ranges between the limits set on the control panel. The preset flow of external air is sucked while an equal air flow is extracted from the ambient.

SUMMER

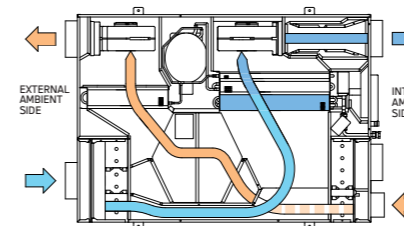

WINTER

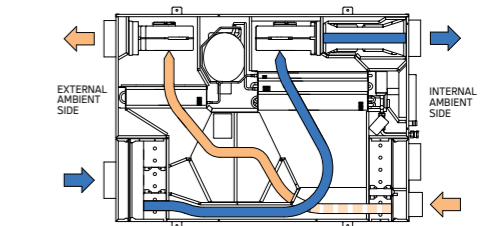



Temperature control for every climate need.
Functional wellness and absolute convenience, for high levels
of thermal comfort in every season.

Chapter 6

Regulation

THERMOREGULATION

INTRODUCTION

The diagram of figure 6.1 shows the devices involved when planning a radiant ceiling for heating and cooling.

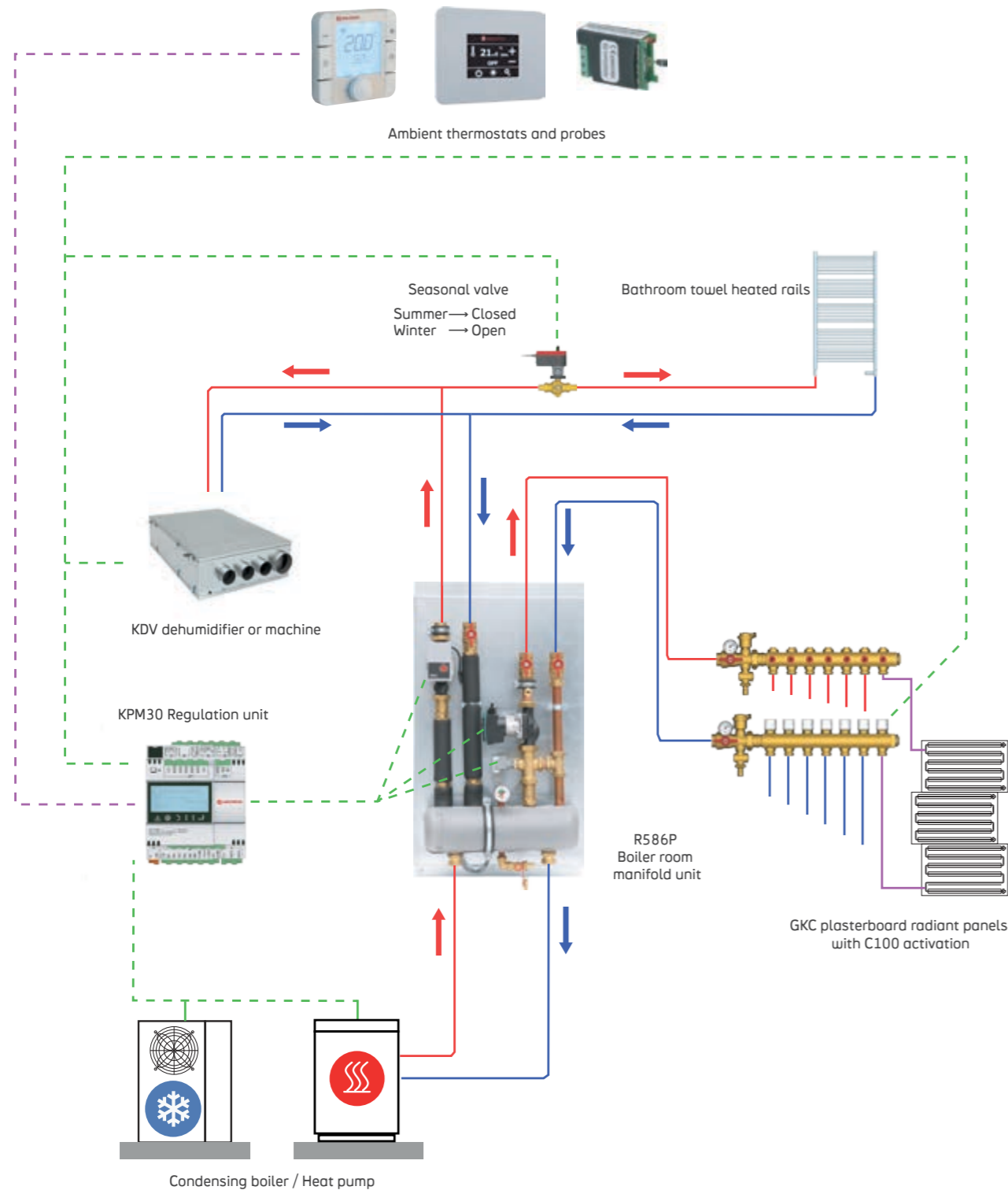

fig. 6.1
Principle diagram for connection of the devices installed in a radiant ceiling system

The following systems are included:

- > **Ambient regulation:** Ambient thermostats with integrated relative humidity sensor enable the user to set the desired comfort conditions
- > **Heating and cooling systems:** the radiant ceiling – supported by the towel heated rails installed in bathrooms – and the dehumidification or VMC machines provide the ambient thermal balance
- > **Machines for the production of hot and cold fluids:** condensing boilers, heat pumps, biomass generators are fitted in proper technical spaces
- > **Devices for fluid temperature control:** the compact R586P boiler room units enable to adjust the temperature of the fluids feeding the various devices involved
- > **Boiler room unit regulation:** based on the user's choices set through the thermostats set-points, the KPM30 electronic unit works as master regulator and controls the boiler room unit, the activation/deactivation of boilers or heat pumps, the centralized seasonal summer/winter commutation. It also offers the possibility to extend the basic functions of the devices involved.

PRIMARY REGULATION

The primary regulation technique implemented by Giacomini control systems follows two different strategies: one for heating, the other for cooling.

Heating: winter climate compensation

Regulation of the delivery temperature when heating follows a specific climatic curve, according to which the heat generators are required low delivery temperatures when the outside temperature remains within relatively high values, while the delivery temperature is also increased until reaching the maximum project temperature when the outside temperature progressively decreases to minimum values:

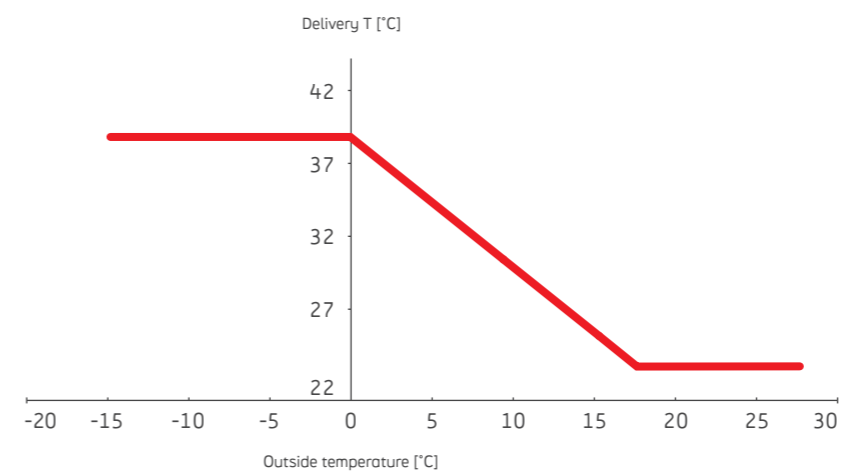

fig. 6.2
Winter climatic curve

This approach is quite significant for applications with uninterrupted use and aims at modulating the thermal emission of the system based on the gradual increase of the building – or apartment – dispersion. At the same time, it enables to optimize the performance of the heat generators¹ and minimizes the dispersions of the distribution network.

Cooling: set point of maximum output power

Regulation of the delivery temperature when cooling aims at a very different goal: search of the delivery temperature maximizing the refrigerating power provided by the radiant ceiling.

This control technique is not possible without using ambient thermostats with integrated relative humidity sensors, which read the dew temperature of every ambient: once the highest is known, the delivery temperature set-point providing the maximum power is immediately set:

$$T_m = \text{Max} (T_{\min}, T_{dp} + F_s)$$

delivery temperature T_m is therefore chosen as the maximum between two values: the minimum delivery temperature T_{\min} set in the regulator and the highest dew temperature T_{dp} increased by a convenient safety factor F_s ².

NOTE

¹ To determination the proper climatic curve an accurate thermal calculation of the monthly average energetic needs of the building is required.
² The safety factor changes according to the system to be adjusted. Typical values are +1 °C for metal radiant ceiling and 0 °C, or also negative values, for plasterboard radiant ceilings.

AMBIENT THERMOSTATS, ELECTRONIC UNITS AND REGULATION SYSTEMS

The range of thermostats that can be combined with radiant ceiling systems is wide many and they can satisfy every installation requirement, from basic to the most refined and automatized installations, which are becoming more popular in modern buildings.

The complete range of thermostats and regulation units includes two different technologic classes:

- > **stand alone** series: thermostats, chrono-thermostats and chrono-thermohumidistats able to function as units autonomous from the regulation units
- > **klimabus** series: blind probes and thermostats with relative humidity sensor, which are parts of a logic, smart and articulated system culminating in the master regulation unit. This type of devices enables the radiant ceiling to work at its best.

STAND ALONE SERIES

The main characteristic of stand alone regulation systems is their capability to interface the primary – in the boiler room – and the secondary regulation – within the ambient, a process which takes place through simple heat exchange of a clean contact. Diagrams 6.3 and 6.4 schematically explain this concept:

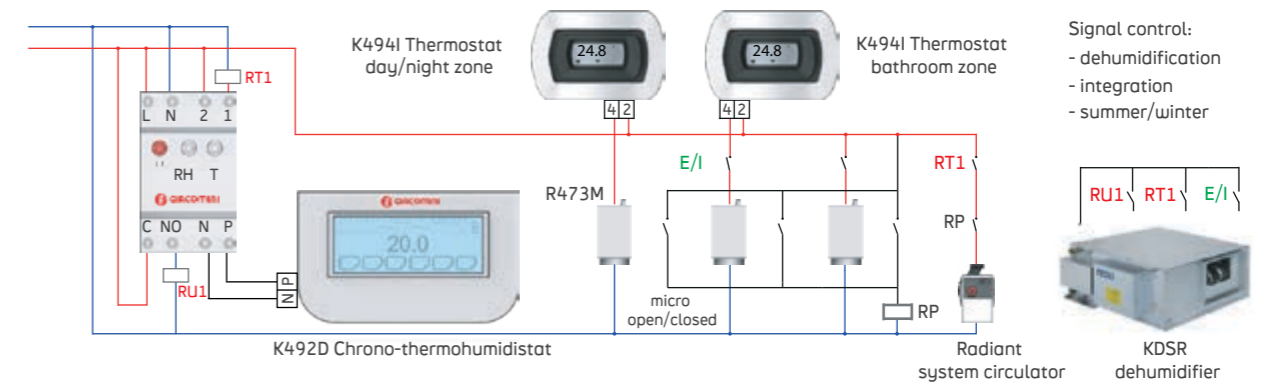

fig. 6.3 Stand alone regulation: radiant ceiling and dehumidifier control

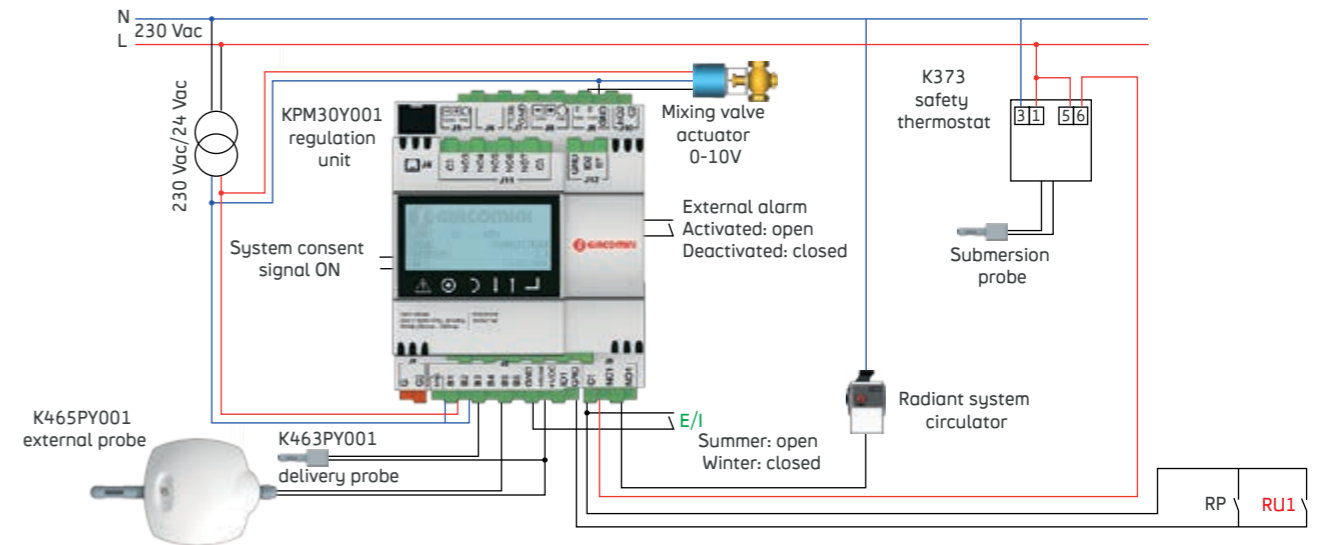

fig. 6.4 Stand alone regulation: mixing valve control

The regulation strategy is based on uncoupling of the local regulation from the boiler room regulation. The ambient includes a chrono-thermohumidistat that works as master and activates the dehumidification machine, in addition to controlling the temperature of its area of pertinence³; other thermostats control the temperature of the corresponding areas. The KPM 30 unit turns the circulator ON/OFF and regulates the radiant system mixing valve. The benefit of this regulation technique stands in its simplicity: a very reduced number of devices successfully controls a complex system. Its limit is that the radiant ceiling cannot reach its maximum power when cooling.

NOTES

³ When installing the system in an apartment equipped with a heat metering module, the same master chrono-thermohumidistat can also turn ON/OFF the zone valve installed in the metering module.

KPM30, KPM31 - stand alone versions

Stand alone control units for heating and/or cooling. The KPM30 model features a display for monitoring, configuration and control of the system.

- 24 Vac power supply, dimension 6 DIN modules
- Possibility to control one or two mixing valves and one or two circulators
- On/off voltage-free contacts for the exchange of summer/winter signals and start/stop consents of boiler room, heat pump, dehumidifiers, fan-coils, electro-thermal actuators
- Possibility to extend the functions with KPM35 expansion modules

The KPM31 unit features the same characteristics of the KPM30 except for the integrated graphic display, so it has to be installed with the KD201 remote graphic terminal (optional for KPM30).



KD201

Semi-graphic terminal with keypad for system monitoring, configuration and control.

- White backlit LCD semi-graphic display
- To be combined with KPM30 or KPM31 regulation modules. Direct power from the regulation module
- Installation in 503 3-compartments wall case



K465P

External temperature passive sensor, range -50 ± 105 °C, in IP68 protection grading case.



K463P

Delivery temperature immersion passive sensor, range -50 ± 105 °C.

- Wire length 6 m, bulb diameter 6 mm



K494

Ambient thermostat for wall-mount exposed installations.

- Battery powered
- Outlet relay with voltage-free exchange contact, 5(3)A, 250 Vac
- Heating and cooling modes with 2 fading levels
- Temperature regulation range 2 ± 40 °C
- 0,5 K differential
- IP20 protection grading



K494I

Electronic ambient thermostat, wall built-in installation

- White or black
- 230 V / 50Hz power or battery feed
- Voltage-free commutation contact; contact range 5(3)A, 250 Vca
- IP 20 protection grading
- Display with graphic icons combined to front keys, setup: comfort, economy, off/ antifreeze
- Available in two versions: winter only or summer/winter control



K490I

Weekly chronothermostat, for wall built-in installation in civil 3-compartments case.

- Battery-powered or electric energy network
- For use with most common civil lines featuring a wide range of covers, frames and adapters
- Outlet relay with voltage-free exchange contact, 5(3)A, 250 Vac
- Heating and cooling mode with weekly, daily, timer and manual programs
- Temperature regulation range 2 ± 40 °C
- 0,25 K differential



K492A, K492D, K492P

Weekly chronothermostat for exposed wall built-in installation, with large touch-screen display.

- Also available as chronothermohumidistat
- For control of electro-thermal actuators (K492A), dehumidifiers (K492D) or fan-coils (K492P)
- Battery-powered. Integrated external module fed by electric network
- Heating and cooling modes with weekly, daily, timer and manual programs
- Integrated relative humidity sensor
- Temperature regulation range 2 ± 40 °C
- 0,25 K differential
- IP20 Protection grading



K499

Control module for all ambient chronothermostats of the K490I and K492 series.

- K499Y001: for GSM remote control
- K499Y010: for local centralized control



KLIMABUS SERIES

A fieldbus-based regulation system enables to enjoy the highest levels in terms of comfort and efficiency. The KPM30Y003 control unit represents the basic diagram of reference to fully understand its potential as shown in the picture (fig. 6.5).

The control unit works as master and with its own bus it exchanges information with one, two or three zone thermostats. It provides three clean output contacts for activation of the actuators corresponding to each zone: in addition, it features two clean contacts for dehumidification or integration of the dehumidification machine or a possible fan-coil.

Plus, the display enables to control or modify the operational set-points or to set the chronoprograms for each thermostat.

The boiler room manifold group is controlled in an extremely rational way: by exchanging information with the ambient thermostats the control unit can activate the radiant ceiling mixing valve and circulator.

The control unit reads the dew temperature of each of the three zones and based on this information it calibrates the temperature set-point for the water to be delivered to the radiant ceiling in order to maximize the provided refrigerating power, while preventing condensation.

With four or more zones, the fieldbus requires must be extended: each KPM30Y004 control unit –regulating only one mixing valve – or KPM30Y005 – regulating two – can control up to 16 thermostats and 7 dehumidification machines. Control of such an extended system, requires the KPM35 expansion modules - according to the diagram of fig. 6.6 on page 108-109.

With this kind of approach, each pair of thermostats is combined to an expansion module to control the actuators based on a temperature signal (upper part of the diagram), while other expansion modules are exclusively dedicated to control the dehumidifiers (or fan coils, if applicable) based on one, or more, - according to the system setup-, humidity signals.

The primary regulation follows the same principle described for the KPM30Y003 3-zones control unit.

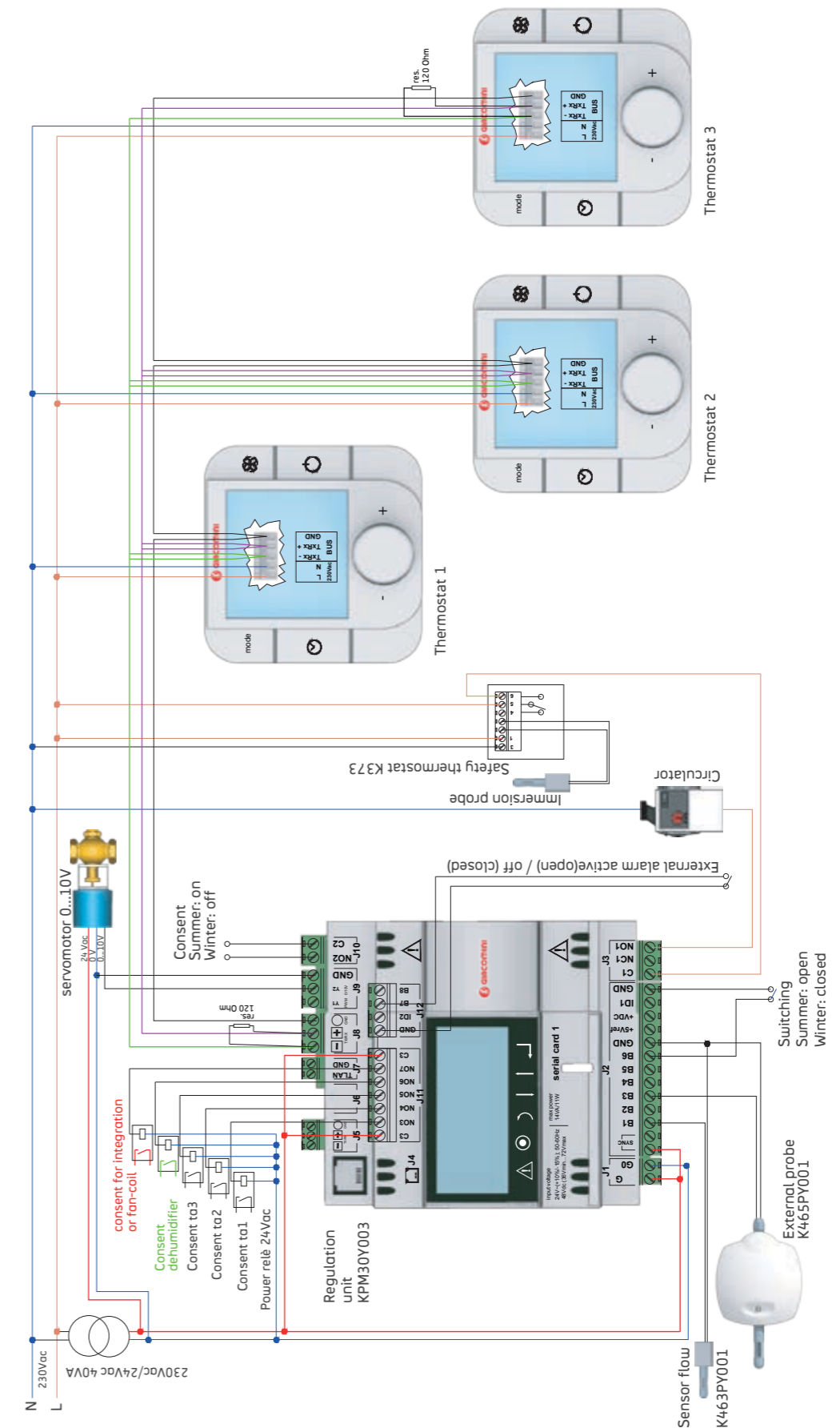
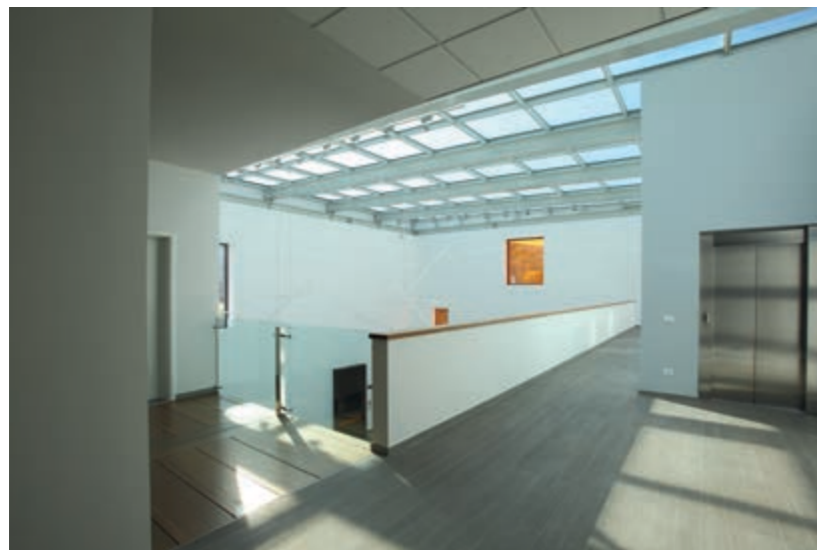

fig. 6.5 Klimabus regulation: complete control of three zones, radiant ceiling and dehumidifier

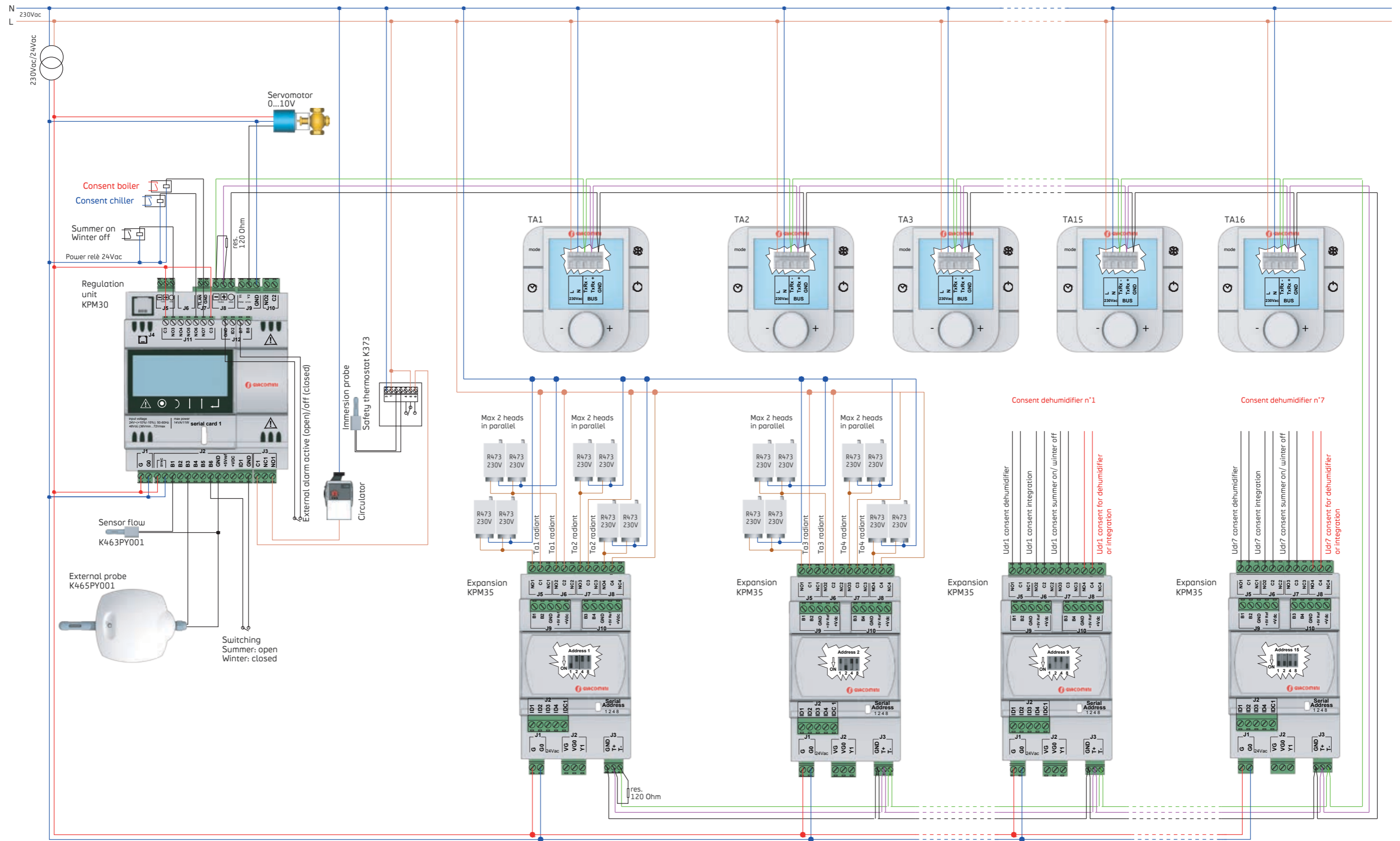

fig. 6.6
Klimabus regulation: complete control of 16 zones, one mixing valve, radiant ceiling and dehumidifiers

KPM30, KPM31 - klimabus versions

Klimabus control units for heating/cooling. The model KPM30 is equipped with display for the monitoring, configuration and system management.

- 24 Vac supply, 6 DIN modules dimension
- Possibility to control one or two mixing valve, and one or two circulators
- Free contact outputs for the exchange of the summer/winter signals and start/stop central boiler consents, heat pump, dehumidifiers, fan-coils, electro-thermal actuators
- KPM35 expansion modules for more functions
- Fieldbus: MODBUS

KPM31 has the same features of KPM30 central unit except for the integrated graphic display - only to be installed combined with the remote graphic terminal KD201 (optional accessory, instead, for model KPM30).



KD201

Semi-graphic terminal with keypad for the monitoring, configuration and management of the system.

- Back white illumination semi-graphic LCD display
- To be combined with the regulation module KPM30 or KPM31. Direct supply out of the regulation module
- Installation with 503 civil wallbox three seats



KPM36

Additional board for KPM30/KPM31 regulation modules. It enables the system integration with other communication protocols: KNX, MODBUS, Ethernet.



K465P

External temperature sensor, the passive type, range $-50\div 105\text{ }^{\circ}\text{C}$, in container with protection grade IP68.



K463P

Immersion delivery temperature sensor, the passive type, range $-50\div 105\text{ }^{\circ}\text{C}$.

- Wire length 6 m, bulb diameter 6 mm



K492B

Thermostat with light-on display and local interface for the control of temperature and humidity.

- 230 Vac of supply, MODBUS communication
- In-wall installation with civil round box



K495L

Thermostat with light-on display and local interface for the control of temperature and humidity.

- 230 Vac of supply, MODBUS communication
- Installation with 503 civil wallbox three seats



K495B

Blind sensor with temperature and humidity sensor.

- 24 Vac supply, MODBUS communication
- Installation with 503 civil wallbox three seats



K493I

Relative humidity and temperature blind sensor.

- In-wall installation on civil series hole cover
- 12 VDC supply, MODBUS communication
- IP20 protection class
- $-10\div 50\text{ }^{\circ}\text{C} \pm 0,5\text{ }^{\circ}\text{C}$ temperature sensor
- $0\div 100\text{ } \% \pm 5\text{ } \%$ relative humidity sensor



K493T

Touch thermostat with TFT color 2,8" display, for temperature control and ambient humidity. Color: white.

- 12 VDC supply, MODBUS communication
- IP10 protection class
- Horizontal installation on three-modules wallbox or Italian standard
- Range $5\div 50\text{ }^{\circ}\text{C}$



KPM35

Expansion output module for KPM30 o KPM31 central units.

- Free-contact outputs with possibility of electro-thermal actuator command, servomotors for zone valves or air treatment systems for dehumidification or integration
- 24 Vac supply, 4 DIN modules dimension



4-PIPES DISTRIBUTION

Radiant ceiling systems are widespread in commercial buildings and hospitals; typical of these applications is the need for a distribution the “4-pipes” type.

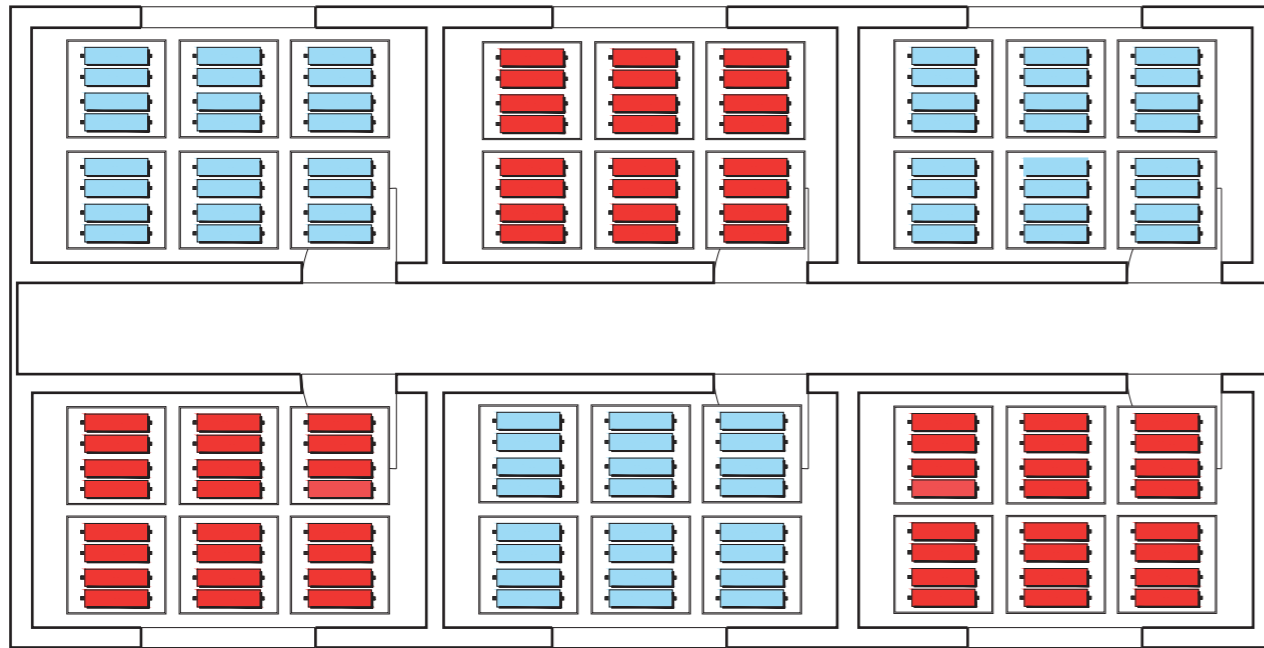

fig. 6.7
4 pipes distribution radiant ceiling system scheme; there is the need to heat some ambients and, at the same time, the need to cool others down.

Thanks to the 6 way valve R274, designed on purpose, it is possible to realize 4 pipes radiant ceiling systems with extreme simplicity:

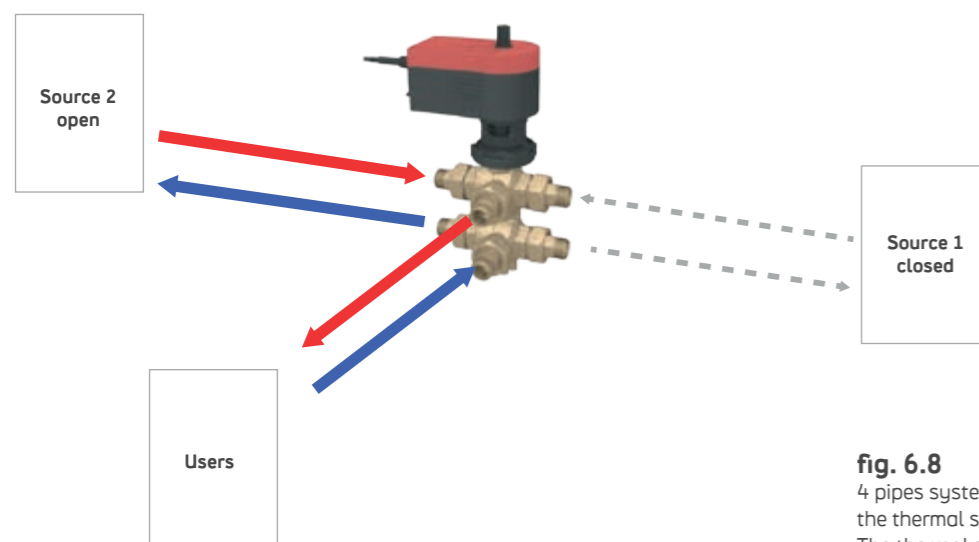

fig. 6.8
4 pipes system: the six-way valve connects the thermal source with the radiant ceiling. The thermal source 2 is intercepted.

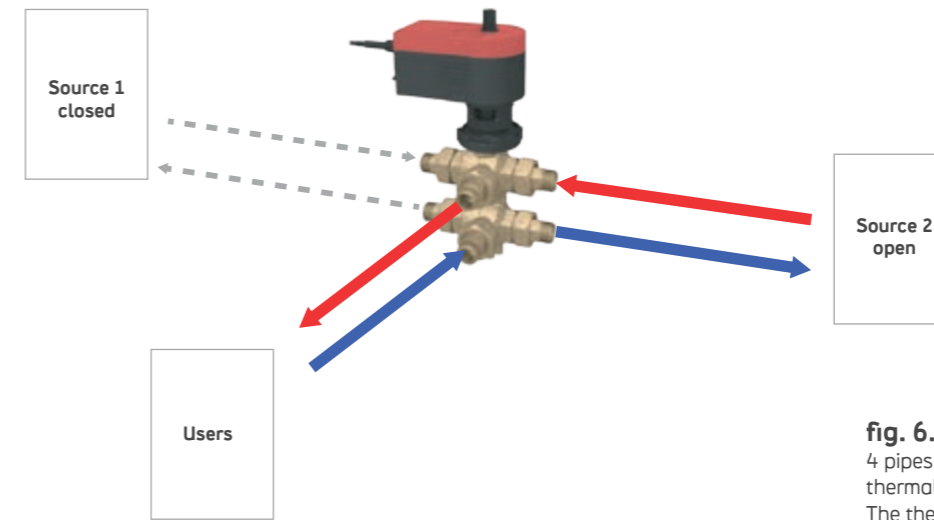

fig. 6.9
4 pipes system: the 6-ww valve connects the thermal source 2 with the radiant ceiling. The thermal source 1 is intercepted.

A single motorized valve can, therefore, replace two motorized valves motorized, easily solving the complication of their opening / closing synchronization linked to the two thermal sources

The R274 six-way valve allows the switch from heating to cooling or vice versa and even the simultaneous shut-off of both thermal sources, acting as a zone valve.

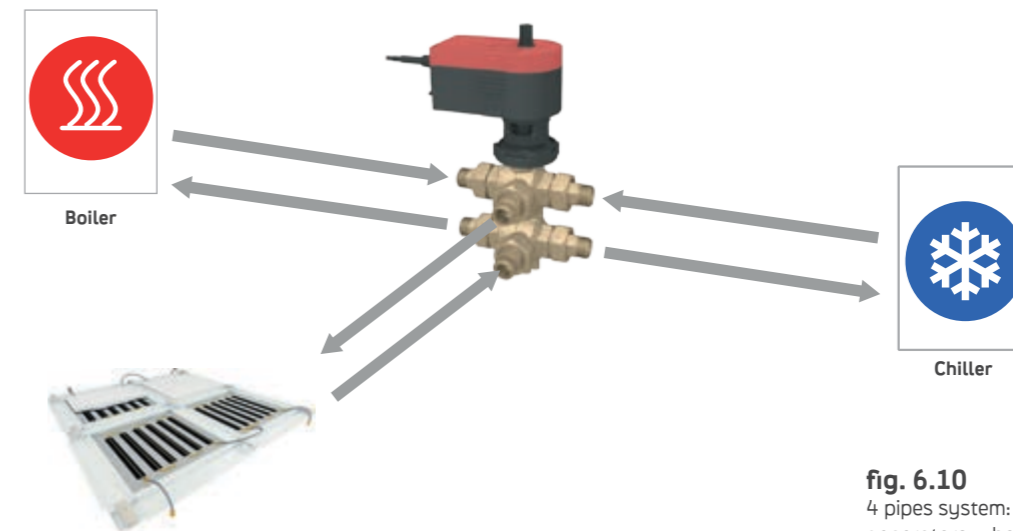

fig. 6.10
4 pipes system: the 6-ways valve is between the generators – boiler and chiller – and the utilizer system – radiant ceiling

A range of solutions designed to adapt to architectural projects of all kinds. A choice that includes the most diverse professionals but is always, absolutely unique.

Chapter 7

The system project

THE SYSTEM PROJECT

INTRODUCTION

After reading of the previous chapters we can now assume that radiant ceiling system projects are actually transversal designs including the cooperation of many different professionals, which are of course implicated in construction or renovation works.

If we think about a residential building, we expect a heating and cooling system to be an integral part of it – and not simply something “contained”.

Therefore, the more discrete its presence, the better. In case we are thinking about the installation of false ceilings, with luminous integrated devices for instance, we should not renounce to them at all; all the same, if we would like to furnish in order to have the walls fully available, we should not abandon our idea just because a heating device must be fixed somewhere.

Going over and over again such needs of everyday life made us actually realize the limitless possibilities that a plasterboard radiant ceiling system has to offer.

If we consider an office building, the architectural requisites to be satisfied will be of other nature: presumably we would like to add an inspectionable false ceiling, which will integrate technical devices of various kinds responding to precise modularity criteria.

Evaluation of the a/m aspects represents the most important moment of all the radiant ceiling system planning. This is also the phase in which we choose the most suitable panel types and bearing structures.

Real thermal dimensioning takes place after dealing with these considerations. The calculation starts from the output graphics of chapter 4 and it is carried out, basically, for cooling first. We then verify that the solution planned satisfies the conditions imposed in heating.

PLASTERBOARD RADIANT CEILING DESIGN

In order to illustrate the project approach of a plasterboard radiant ceiling system we may take in consideration the apartment represented in figure 7.1.

The map shows the wide open-space day area – living room, dining room and entrance – and the night area, including three bedrooms. There are two service bathrooms and a main one.

The plan includes a plasterboard false ceiling including several built-in spotlights, all indicated on the map. The dining area will feature a false ceiling not completely coplanar, being present a round-shaped portion located at a higher point from the floor as opposed to the rest of the false ceiling.

In the end, there is a pillar in the living room; this pillar does not represent an obstacle in case of installation of passive plasterboard panels, as they can be cut on measure, but it certainly represents a sensible impediment in case of active panel installation that we have to consider so to exploit at its best the useful surface.

As we are dealt with such bonds the best choice to be done is the one to use the GKC series, that enables to easily place the spotlights inside the active panels, without for this reason reduce the radiant surface.

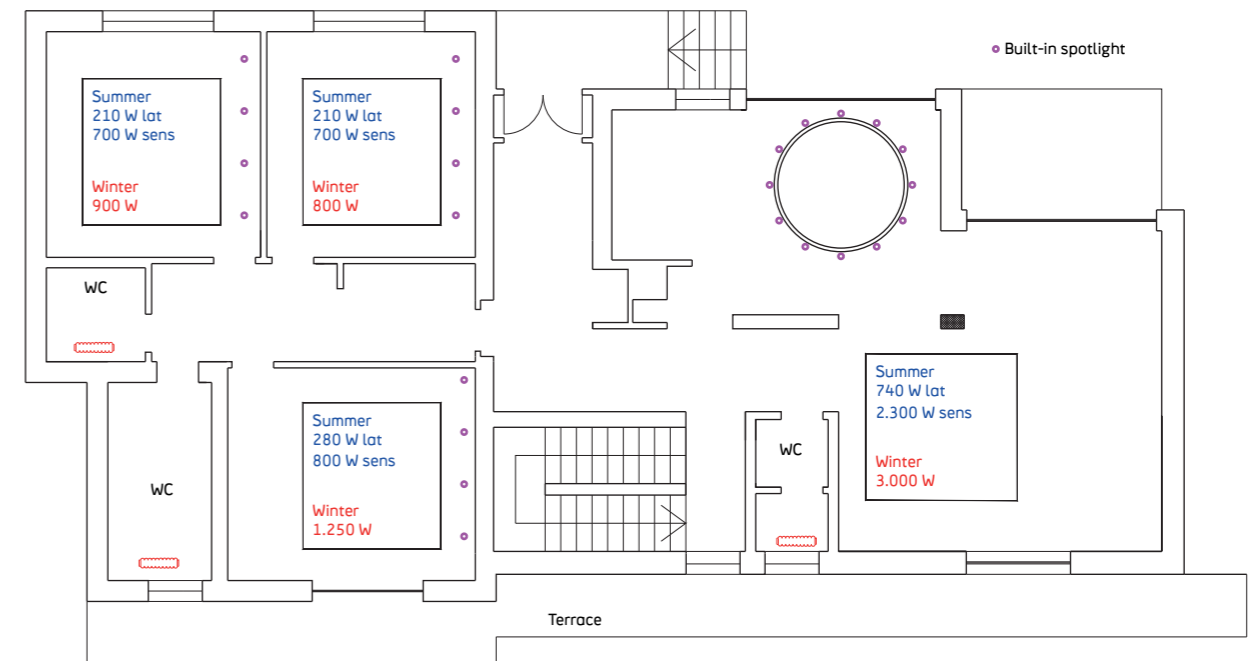

fig. 7.1
Apartment with thermal loads indications, built-in spotlights and circular decoration non coplanar with the rest of the false ceiling

Bathroom dimensions, along with the fact that their cooling is not required, suggest to treat their heating with furnishing radiators.

Thermal loads are indicated on map, both for heating and cooling: in this case the load is divided in the sensible and latent components. Considering the ambient disposition and the latent loads in play, it is reasonable to decide to install two machines for dehumidification: one at the service of the night area, one dedicated to the day zone.

The overall latent load of the night area is equal to 700 W, the one of the day zone is 740 W.

Two KDSRY026 machines are fit for the application.

Besides dehumidification, any machine makes available also 950W of sensible refrigerating power. The designer can choose to consider this contribute as a power reserve, so he can pass to the next step of dimensioning the false ceiling by integrally considering the sensible loads reported on the map.

Thermal and refrigerating calculations related to the radiant ceiling are carried out according to what we already described in chapter 4. To simplify, we adopt the output panels indicated in the table “Project typical outputs” (fig. 4.14) at the end of chapter 4.

Based on loads and architectonic bonds we arrive at the radiant false ceiling scheme shown in figure 7.2, in which only the active panels are indicated: panels of the same colors are meant as part of the hydraulic circuit.



fig. 7.2
GKC radiant ceiling scheme, with indication of circuits, manifolds and dehumidifiers

Exploiting the Kv values indicated in figure 7.6 and considering the load losses of the pipe segments connecting panels to manifolds, we obtain the table in figure 7.3 that sums up calculations and in which one can see that the system satisfies the project bonds and balances thermal and refrigerating loads.

GKC RADIANT CEILING CALCULATION

manifold	circuit	panel no. 1200x2000	panel no. 1200x1000	panel no. 600x2000	summer output [W]	winter output [W]	supply [l/h]	Δp circuit [mm.c.a.]
C1	Circuit 1	2	1		355	495	153	1137
	Circuit 2	3	2		568	792	245	3057
	Circuit 3	2	2		426	594	184	1627
	Circuit 4	2	2		426	594	184	1627
	Circuit 5	3	1		497	693	214	2245
C2	Circuit 1	3			426	594	184	1767
	Circuit 2	3			426	594	184	1544
	Circuit 3	3			426	594	184	1544
	Circuit 4	3			426	594	184	1289
	Circuit 5	3			426	594	184	1289
	Circuit 6	3		1	497	693	214	2075
	Circuit 7	1			142	198	61	389

fig. 7.3

According to chapter 6, the overall scheme of the entire system is the one of figure 6.1, while the regulation strategy more convenient is the one corresponding to the scheme of figure 6.6.

METAL RADIANT CEILING SYSTEM PROJECT

As an example for the planning of a metal radiant ceiling system, let's consider the environments of map indicated by fig. 7.4. It is an area that includes one open-space part and some compartments, among which is a meeting room. Space internal division is made by mobile walls ending at the false ceiling, so it has to be treated as a continuous coplanar false ceiling. The lighting system includes suspended light spots behind the false ceiling, they do not interfere with the system distribution scheme.

There is, however, a bond due to modularity – irregular because of the interdistances of 4.842 mm, 4.842 mm, 4.998 mm – introduced by the pillars laying on the perimeter of the entire environment. The best solution is the GK series, particularly indicated to be used in wide environments and in structures realized with mobile walls. The definitive choice is for the elegant GK120, in silver, though under a strict thermal performance standpoint also the GK60 is equally adequate.

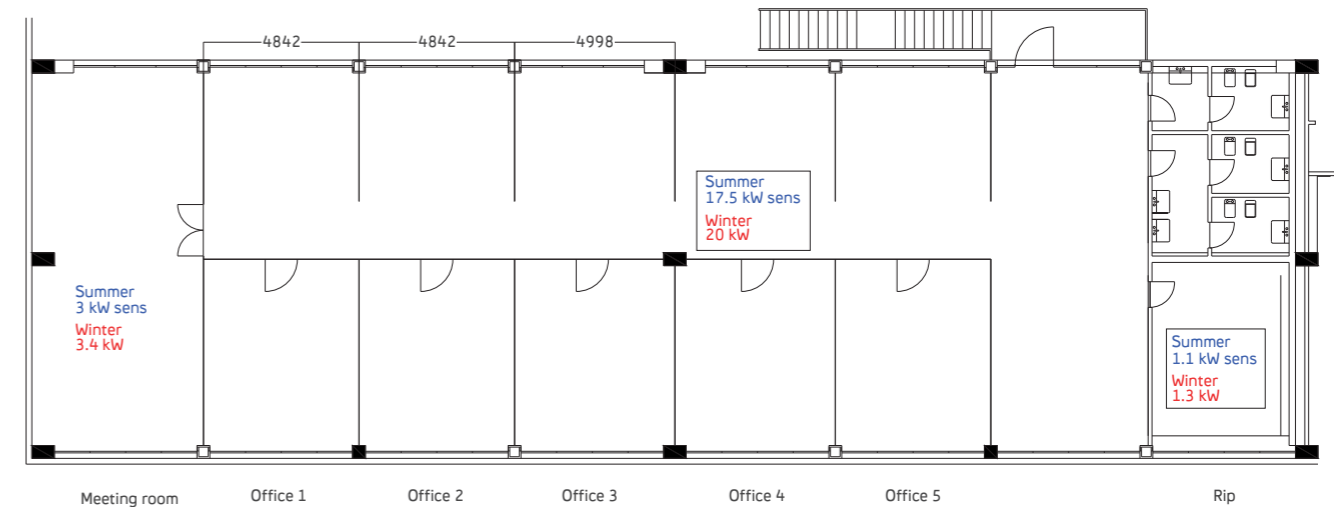

fig. 7.4
Office area in part open space, in part as compartments. Pillar irregular modularity is clear

The system is completed with an air treatment device in charge for hygienic exchanges and participates in the balancing of thermal loads, based on what we say in the introduction of chapter 5; for this reason the thermal loads reported on the map are only the sensible ones and are those on which the radiant ceiling has to be proportioned.

As just happened in the previous example, here too we adopt the panel outputs indicated in the table "Typical project outputs" (fig. 4.14) at the end of chapter 4.

Based on loads and architectural bonds we reach the radiant false ceiling scheme shown in fig. 7.7, page 122-123, from which we can

notice that the use of some non-standard elements for a part of the bearing structure has been necessary: the use of only 150 mm base components would not have enabled to respect the modularity bond, so some base 192 mm and 492 mm support have been introduced.

Such choices, although they may seem expected, must be worked out very carefully along with Giacomini S.p.A. technical support.

In this scheme as well, panels with the same colors must be considered as part of the same hydraulic circuit.

As we will notice, architectural modularity turned out as installation modularity. The system geometry leads to a panel-batch “base unit” in several circuits, all formed by 4 panels connected in series among themselves. In order not to add weight to the treatment in vain, it is convenient to limit the calculation to the level of “standard manifolds”; in this case we individuate one C1 manifold supplying 4 circuits, any of the 4 GK120 panels and a C2 manifold serving 3 circuits, made of 4 panels too.

C1 manifold recurs 14 times, type C2 just once; therefore, the calculation result of C1 must be multiplied for 14 times to establish powers and supplies globally played by the radiant ceiling.

Having said that, by exploiting Kv values in the table of fig. 7.6 and considering pressure losses of the pipe segments connecting the panels to each other and the manifolds, we obtain the table in fig. 7.5 that sums up the calculations and in which we can see that the system satisfies the project bonds and balances thermal and refrigerating loads.

System regulation is instead derived by the schemes contained in chapter 6.

GK120 RADIANT CEILING CALCULATION

manifold	circuit no.	no. of active panels installed	summer performance [W]	winter performance [W]	summer supply [l/h]	winter supply [l/h]	pipe length 16x1,5 [m]	Δ_p [mm c.a.]	max Δ_p to manifold	collector ways
C1	Circuit 1	4	388	436	167	125	15	2519	2.519	4
	Circuit 2	4	388	436	167	125	15	2519		
	Circuit 3	4	388	436	167	125	15	2519		
	Circuit 4	4	388	436	167	125	15	2519		
C2	Circuit 1	4	388	436	167	125	15	2519	2.519	3
	Circuit 2	4	388	436	167	125	15	2519		
	Circuit 3	4	388	436	167	125	15	2519		

fig. 7.5

SUMMARY TABLES

The following tables report the technical data useful in the planning of radiant ceiling system.

WATER CONTENT AND Kv

panel	activation	water content [Lt]	Kv
GK60x60 PSV	C75	0,16	0,95
GK60x60 PSV	A220	0,31	2,30
GK60x120 PSV	C75	0,24	0,77
GK60x120 PSV	A220	0,64	2,11
GK60	C75	0,29	0,86
GK60	A220	0,64	2,11
GK120	C75	0,43	0,73
GK120	A220	1,18	1,52
GKCS v.2.0 - 1200x2000	8x1 coil	1,00	0,10
GKCS v.2.0 - 600x2000	8x1 coil	0,50	0,10
GKCS v.2.0 - 600x1200	8x1 coil	0,30	0,12
GKCS v.2.0 - 1200x1000	8x1 coil	0,50	0,10
GKC - 1200x2000	C100	2,00	1,42
GKC - 1200x1000	C100	1,10	1,97
GKC - 600x2000	C100	1,10	2,70

fig. 7.6

WEIGHTS

radiant ceiling	weight [kg/m ²]	water content [Lt]
GK series	11	16
GK PSV series	11	12
GKC series	12	19
GKCS v.2.0 series	15	15

Weights indicated include bearing structure

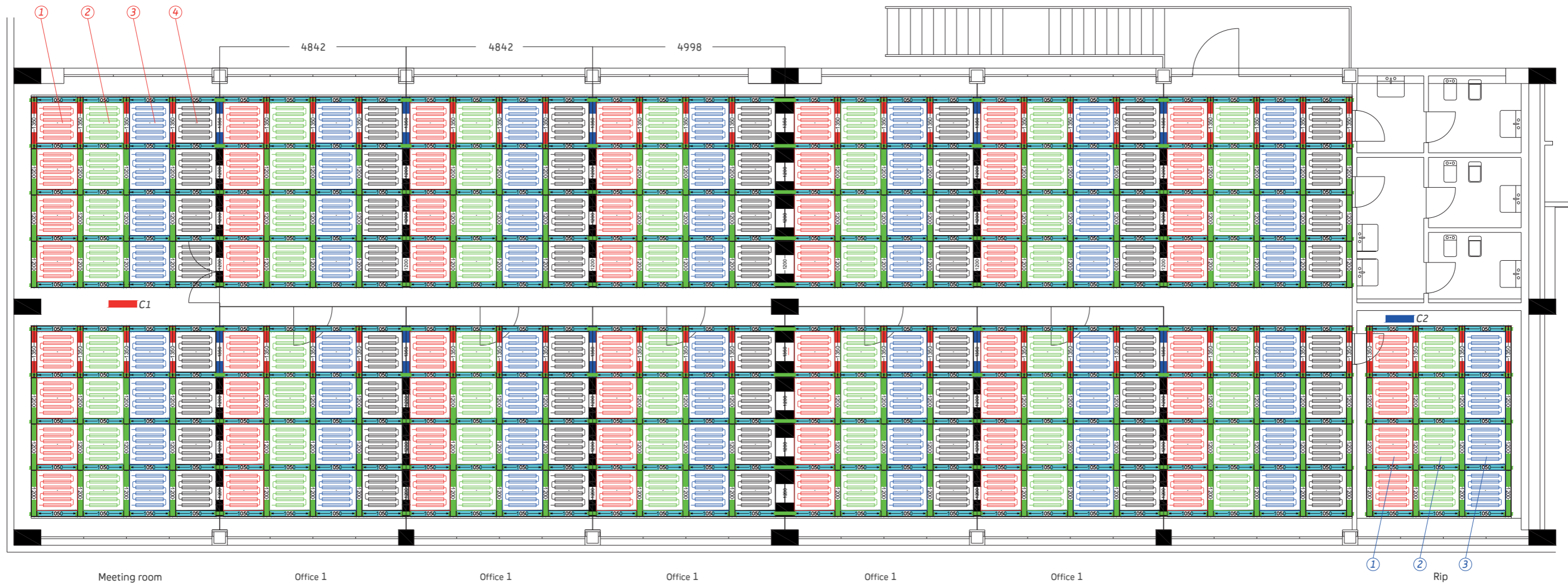

SYMBOL LEGEND











	Head primary support 192x1350		Primary support 150x1200
	Primary support 192x1200		Secondary support 150x1050
	Head primary support 492x1350		Bracket for supports
	Primary support 492x1200		Radiant panel GK 120
	Head primary support 150x1350		Radiant ceiling manifold

fig. 7.7
GK120 radiant ceiling scheme

Fundamental steps to ensure any time a flawless installation and maximum efficiency of use in total safety.

Chapter 8

**General prescriptions
and testing procedures**



GENERAL PRESCRIPTIONS FOR THE REALIZATION OF RADIANT CEILING SYSTEMS

Indications for pre-installation steps

- > Check available spaces and installation height
- > Check surface stability of anchoring of the hangers
- > Check project drawings correspond to the real situation
- > Check that surfaces correspond to project drawings

Indications for material stocking

- > Check the good state of the material delivered
- > Stock the material in a dry and dark place
- > Handle the material with care to avoid scratches, bends and brakes

Indication for the installation process

- > Before installation, analyze the project drawings and read the instructions contained both in project and the instruction papers included with the single products
- > Follow the project drawings; any change requires designer agreement
- > When connecting RC push-fitting joints use RC900 reinforcement bushes and check depth piping insertion
- > Use only Giacomini S.p.A.'s material for clamping unless otherwise agreed
- > In case of components with protective film (for example pre-painted elements) remove the film the moment before installation

System supply water specifications

- > Take at least 1 liter of supply water and analyze it to verify the parameters indicated in table of fig. 8.1 (minimum required features for supply water) and adjust with appropriate treatment plant just in case

MINIMUM FEATURES REQUIRED FOR SYSTEM WATER

parameters		value	expected inconvenients in case of indicated limit breaks
pH		6,8-8,0	Corrosion and scales
electrical conductivity	[mS/m] a 25 °C	<10	Corrosion and scales
chlorides	[mg Cl/l]	<25	Corrosion
sulphates	[mg SO42-/l]	<25	Corrosion
hardness	°F	<15	Scales
iron	[mg Fe/l]	<0,2	Corrosion and scales
copper	[mg Cu/l]	<0,1	Corrosion
sulfide ion	[mg H2S/l]	ABSENT	Corrosion
ammonium ion	[mg NH+4/l]	<0,5	Corrosion

fig. 8.1

Indications for the system testing and running

- > Follow the indications for the pressure and filling test of the system (if not available, please ask Giacomini S.p.A.)
- > Introduce K375 protective solution into the system, according to modes and doses indicated in the enclosed instructions

Panel cleansing

- > For a correct cleansing of the system remove the dust from painted surfaces with clean and soft cloth. Grease and dirt must be removed with a suitable and delicate detergent. Do not use corrosive detergents and avoid scratching the surfaces.

TESTING PROCEDURE FOR RADIANT CEILING

Radiant ceiling systems, as all systems containing fluids, must be tested after installation and before use in the environments in which they are installed.

Testing procedures, which must be strictly carried out as represented below, are the following:

1. Air pressure test
2. Room temperature water pressure test
3. Heated water pressure test
4. Refrigerated water pressure test

1. Air pressure test

Once the panel connection to the distribution manifold is completed, as well as connection of the latter to the distribution network, a first pressure test with compressed air at at least 4 relative bar shall be executed: in case a sufficiently powered compressor is available, it is most convenient to test at the nominal exercise pressure of 6 bar.

The pressure test must be performed with all radiant ceiling circuits.

In order to carry out the test successfully, we must intercept the automatic air exhausts and feed one by one the system circuits. In case of localized loss inside a circuit, ball valves on supply lines must shut off and may act in order to eliminate the cause of the loss.

Circuits must be tested for no less than 24 hours; then we empty the air out so to return to the atmospheric pressure inside the circuits.

2. Room temperature water pressure test

After having reopened the air exhausts and the ball valves on the supply lines we proceed with the feeding of the supply network with water at room temperature; after having eliminated all the air present, we proceed by feeding one by one the radiant circuits leaving to the air present into the rings the time to exit through the automatic outlets. When all circuits are filled with water we raise the exercise pressure verifying the absence of losses. Then, system circulators are turned on so to let out the last air bubbles present in the circuit.

To carry out correctly this operation on large systems we may proceed in advance with a general balancing of the rings to avoid that water circulates only in those with less pressure loss and circulates a little or for nothing in those characterized by major pressure losses.

When the air has completely gone from the system – after about 24 hours – circulators can be stopped and pressure can be raised to 1.5 times the exercise pressure with a minimum of 6 bar. In such conditions the system must be left for at least another 24 hours, during which we check the system sealing. In case of water leaks we must proceed by intercepting the ball valves on the supply lines and act so to determine the cause of the loss. Once completed the test cycle, pressure is restored to the service value.

3. Heated water pressure test

By keeping the pressure system at the service value, with the circulators running, we slowly bring water temperature to 40 °C and we let the system operating for about 24 hours. Then, always with the circulators running, water is left to cool down until it reaches room temperature.

The purpose of this test is to check water circulation inside all radiant ceiling circuits, as well as test the pipings, joints and junctions among panels at a thermal cycle that enables to eliminate installation tensions stabilizing the couplings.

4. Refrigerated water pressure test

By keeping the system pressure at the service value, with the circulators running, we slowly bring water temperature to 12 °C – in case of plasterboard radiant ceiling – or to 15 °C – in case of metal radiant ceiling – and we let the system running for about 24 hours. Then, always with the circulators running, we let water cool down to room temperature.

To avoid condensation phenomenon on the panels, carry out this test requires low values of absolute humidity in the environment of installation.

In case of high humidity levels, i.e. implying dew temperature over 13 °C, treatment machines might be turned on so that the environment humidity can be controlled and kept within a range that prevents condensation.

Final notes

Testing described at points 1 and 2 are indispensable.

Testing as of points 3 and 4 are strongly recommended because system components undergo a cyclical test of temperature and combine to the test a safety grade very high. In addition, during the test as of point 3 or 4, we recommend to carry out the complete thermovision of the system, in order to verify the correct superficial temperatures of the radiant ceiling.



Via per Alzo, 39
28017 San Maurizio d'Opaglio (NO) ITALY

Tel. +39 0322 923111

giacomini.com